

WEST ELEVATION

6" BEVEL SIDING

ALL BRICK
4" x 8" - 4 LT.

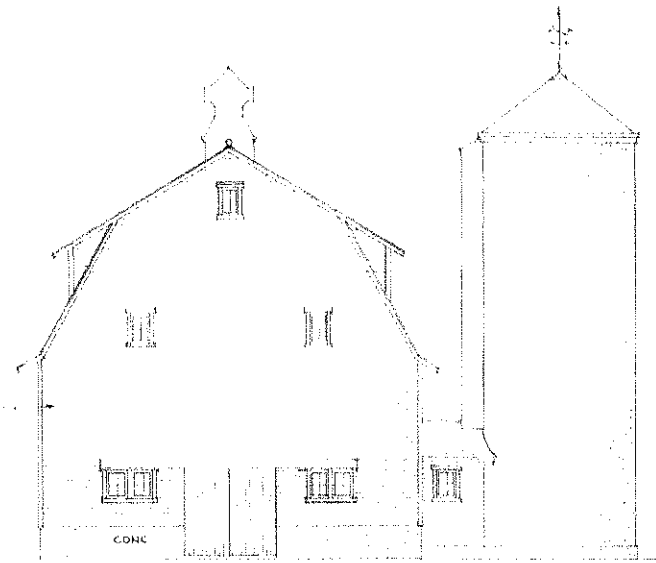

SOUTH ELEVATION

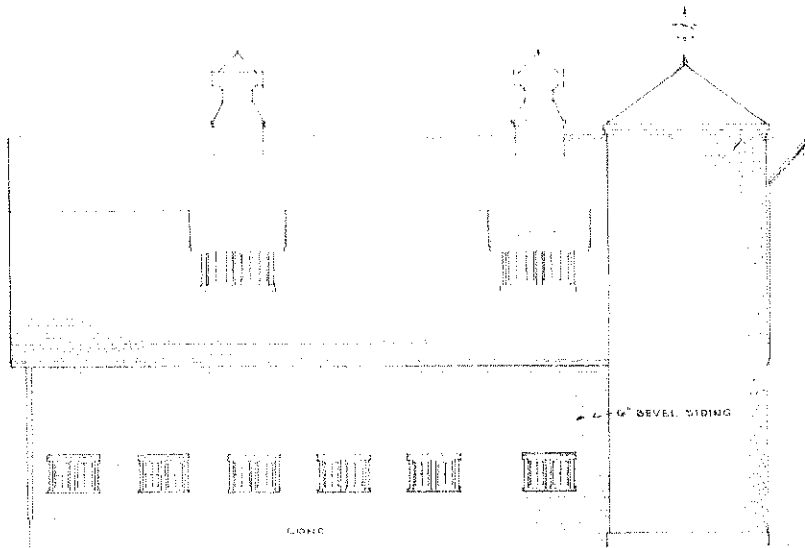

EAST ELEVATION

6" BEVEL SIDING

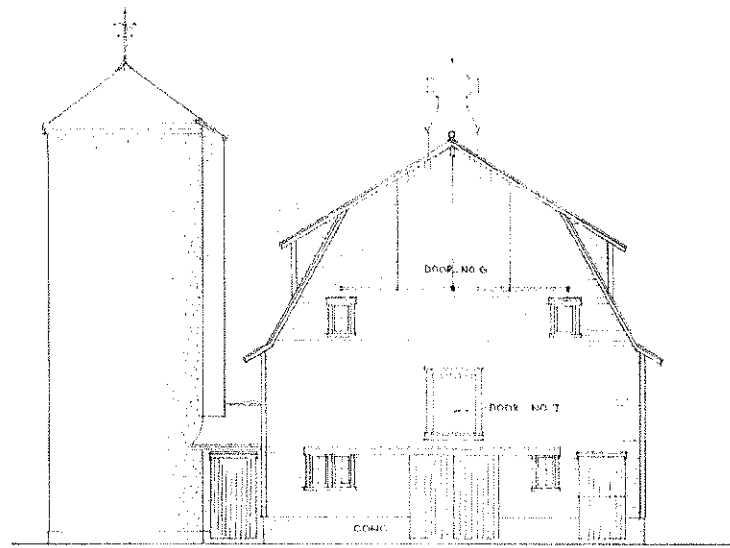

NORTH ELEVATION

DOOR NO. 6

DOOR NO. 7

SCALE OF DRAWINGS ON THIS SHEET 1/8" = 1'-0"

COOPERATIVE EXTENSION WORK IN
 AGRICULTURE AND HOME ECONOMICS
 STATE OF NORTH DAKOTA
 NORTH DAKOTA AGRICULTURAL COLLEGE
 AND
 U. S. DEPT. OF AGRICULTURE - COOPERATING
 EXT. AGR. L. ENGINEER - FARGO, N. DAK.

DAIRY BARN

MIDWEST 72311-33 EX. 5250 SHEET 1 of 7

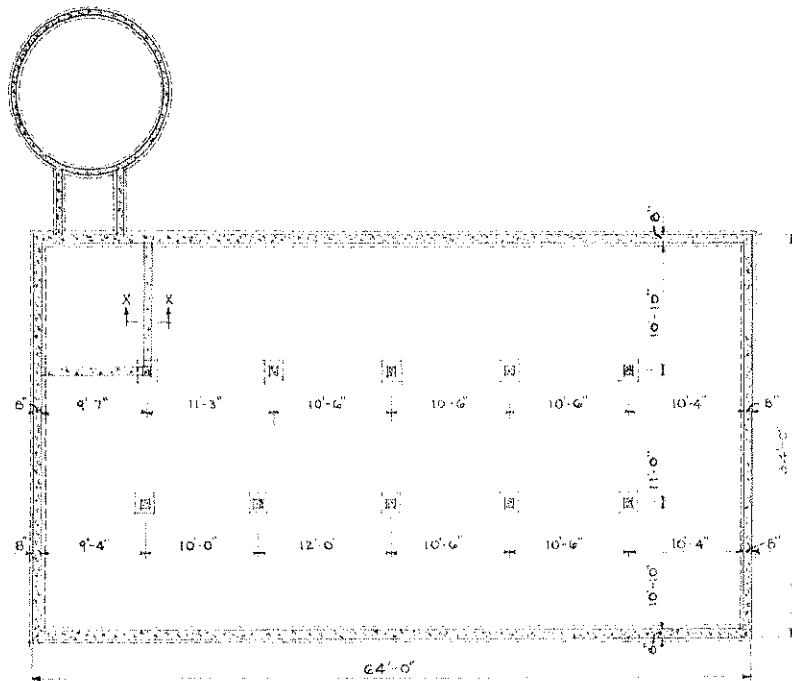

FOUNDATION PLAN
SCALE $\frac{1}{8}'' = 1'-0''$

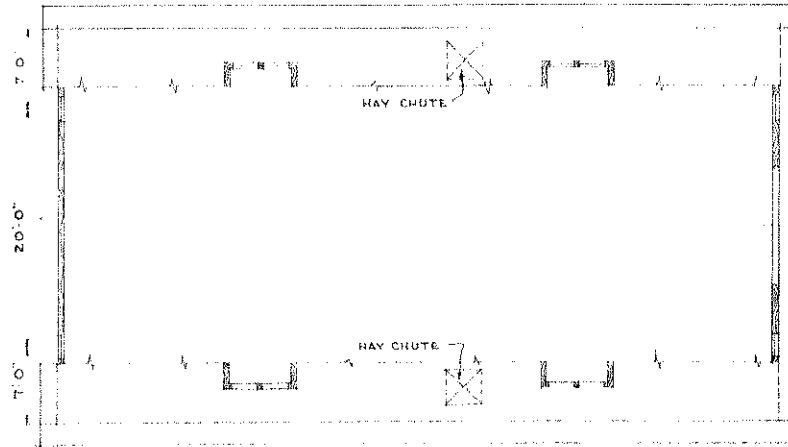

LOFT PLAN
SCALE $\frac{1}{8}'' = 1'-0''$

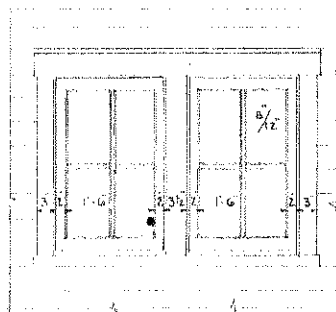

ELEVATION

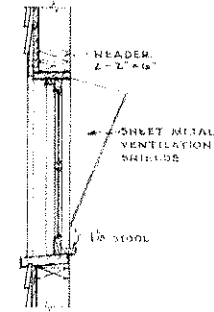

VERTICAL SECTION

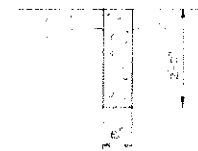

FOOTING SECTION X-X
SCALE $\frac{1}{2}'' = 1'-0''$

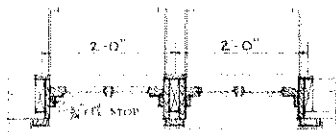

HORIZONTAL SECTION
DOUBLE WINDOW DETAILS
SCALE $\frac{1}{2}'' = 1'-0''$

DOOR SCHEDULE					
NO.	QTY.	WIDE	HIGH	THICK	DESCRIPTION
1	4	4'-3"	8'-4"	1 1/2"	2 AT EACH OPENING
2	2	3'-6"	7'-0"	1 1/2"	CUT TO MAKE DOUBLE 5'6"x7'
3	2	3'-6"	7'-0"	1 1/2"	
4	1	3'-0"	7'-0"	1 1/2"	
5	1	2'-4"	7'-0"	1 1/2"	
6	2	5'-3"	12'-0"	1 1/2"	HAY DOOR IN GABLE
7	1	4'-0"	5'-0"	1 1/2"	LOFT DOOR, NORTH END

COOPERATIVE EXTENSION WORK IN
AGRICULTURE AND HOME ECONOMICS
STATE OF NORTH DAKOTA
NORTH DAKOTA AGRICULTURAL COLLEGE
AND
U. S. DEPT. OF AGRICULTURE COOPERATING
EXT. AGR'L. ENGINEER - FARGO, N. DAK.

DAIRY BARN

MIDWEST 72511-35 EX. 5291 SHEET 20 of 7

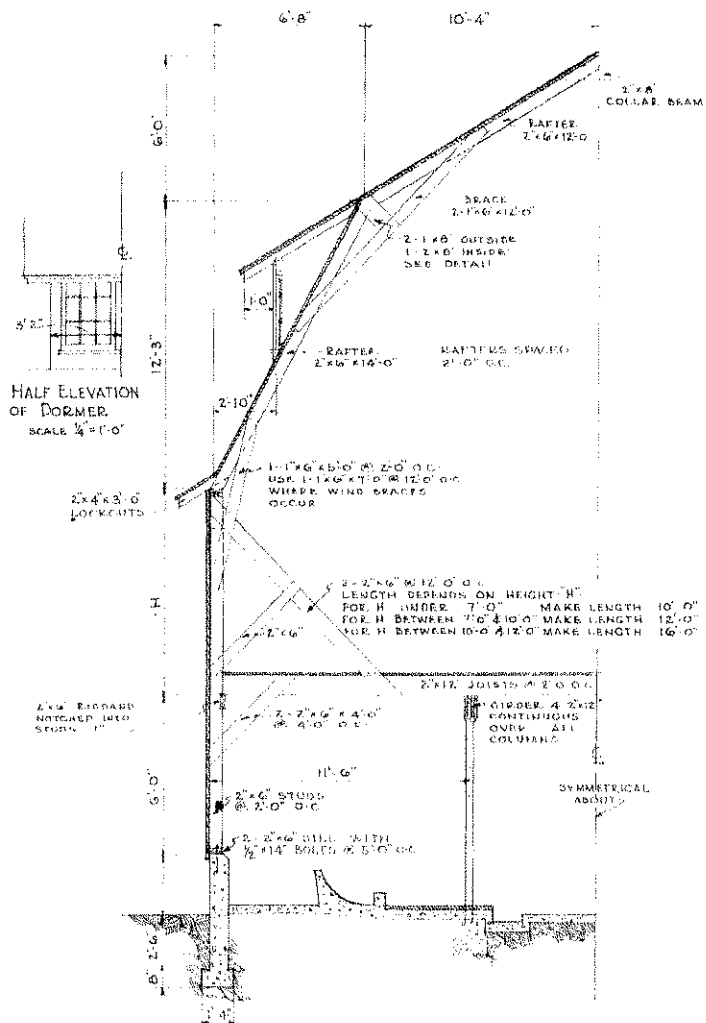

HALF ELEVATION OF DORMER
SCALE 1/4" = 1'-0"

HALF CROSS SECTION
SCALE 1/4" = 1'-0"

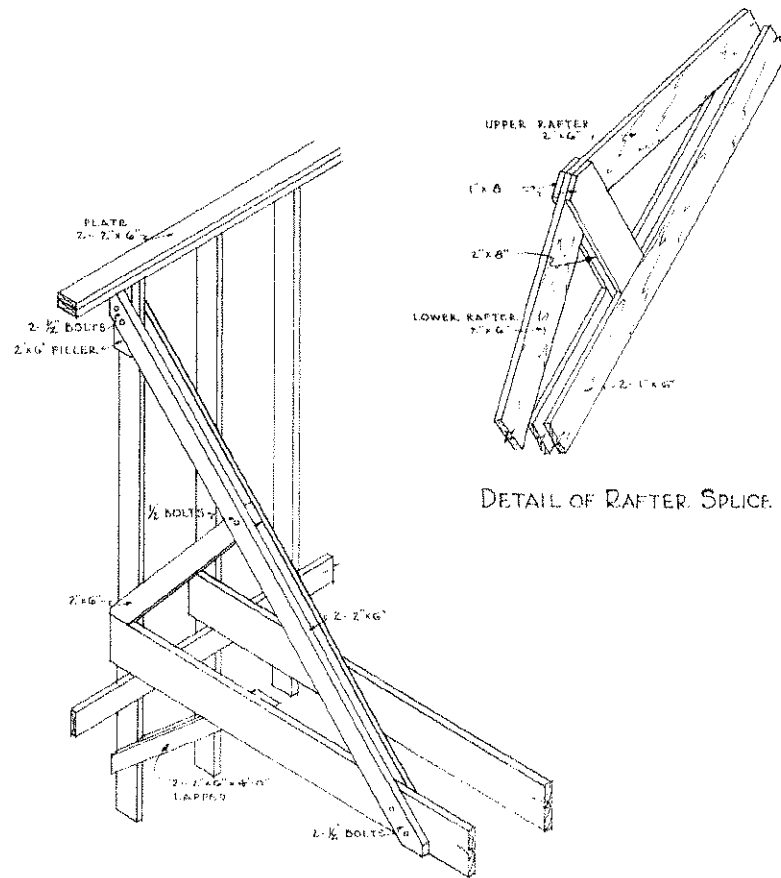

DETAIL OF RAFTER SPLICE

DETAIL OF WALL BRACE
SPACE 17'-6" O.C.

COOPERATIVE EXTENSION WORK IN
 AGRICULTURE AND HOME ECONOMICS
 STATE OF NORTH DAKOTA
 NORTH DAKOTA AGRICULTURAL COLLEGE
 AND
 U. S. DEPT. OF AGRICULTURE COOPERATING
 EXT. BUREAU ENGINEER-FARGO, N. DAK.
DAIRY BARN
 MIDWEST 72311-33 EX. 5252 SHEET 3 of 7

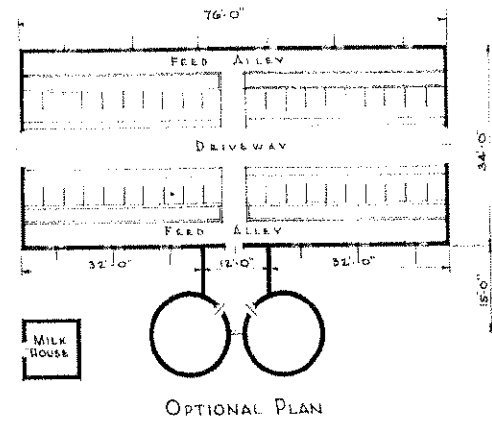
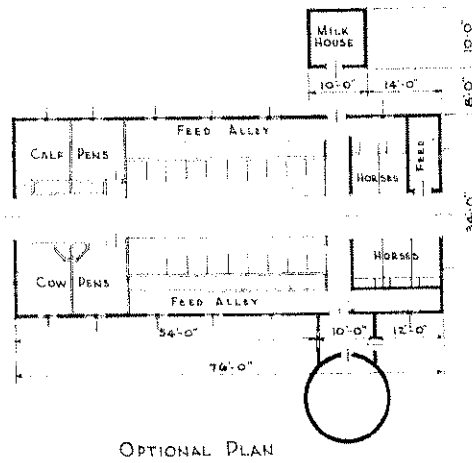
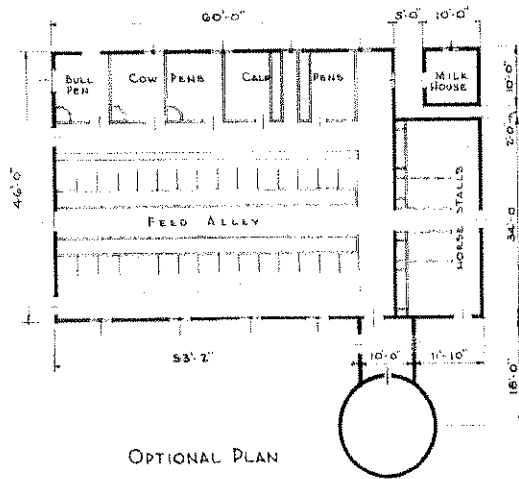

SCALE OF OPTIONAL PLANS $\frac{1}{16} = 1'-0"$

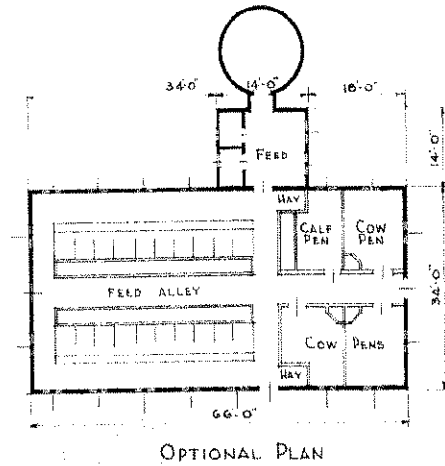
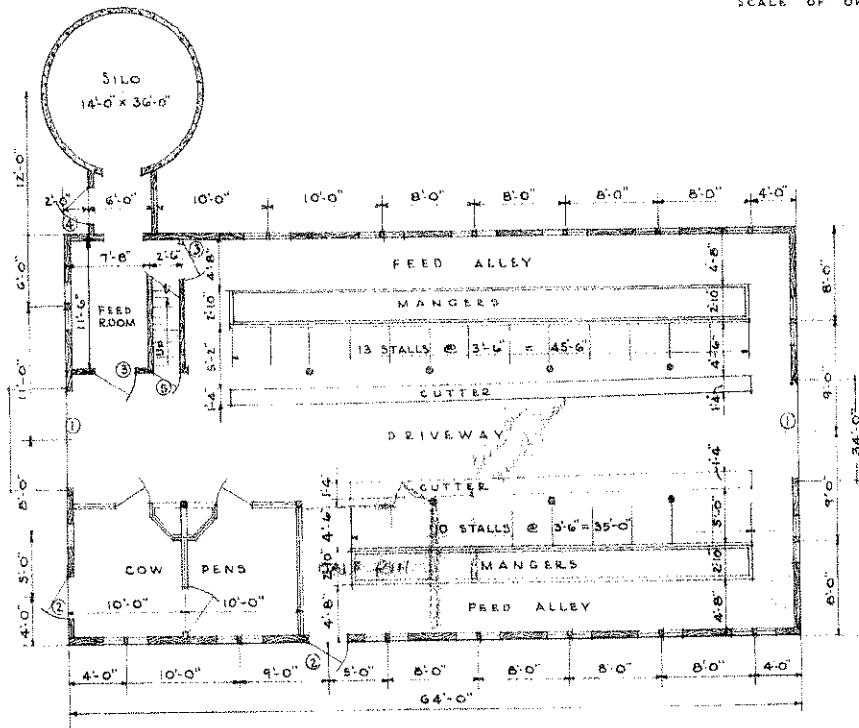

COOPERATIVE EXTENSION WORK IN
AGRICULTURE AND HOME ECONOMICS
STATE OF NORTH DAKOTA
NORTH DAKOTA AGRICULTURAL COLLEGE
AND
U. S. DEPT. OF AGRICULTURE COOPERATING
EXT. AGR'L ENGINEER—FARGO, N. DAK.

DAIRY BARN

MIDWEST 723H '33 EX. 5253 SHEET 4 OF 7

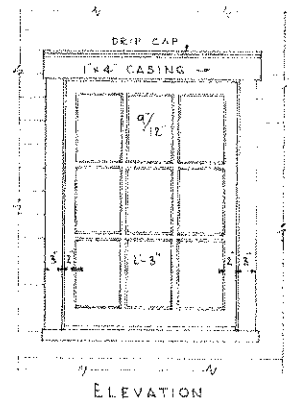

ELEVATION

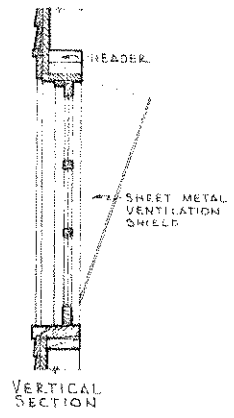

VERTICAL SECTION



HORIZONTAL SECTION

TYPICAL WINDOW DETAILS
SCALE 3/4"=1'-0"

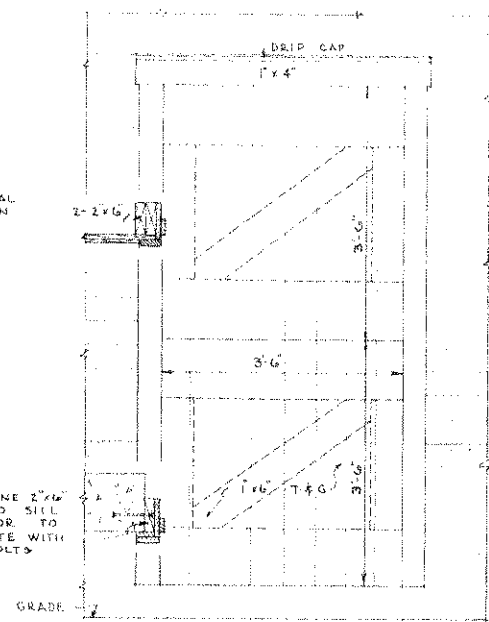

TYPICAL HINGED DOOR DETAILS
SCALE 3/4"=1'-0"

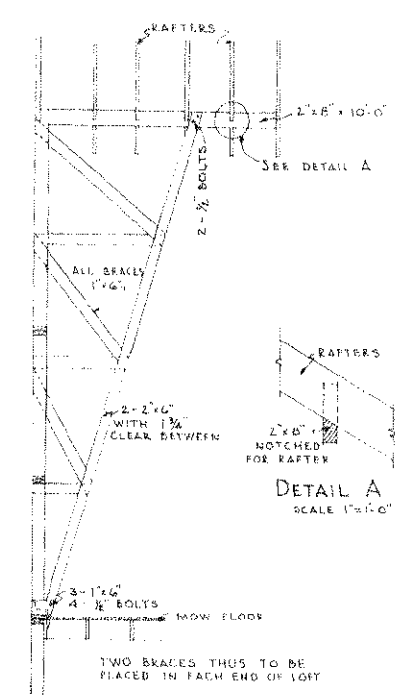
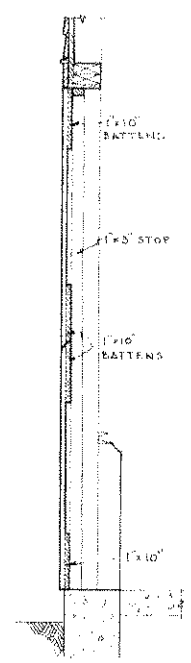

WIND BRACING FOR GABLE
SCALE 1/4"=1'-0"

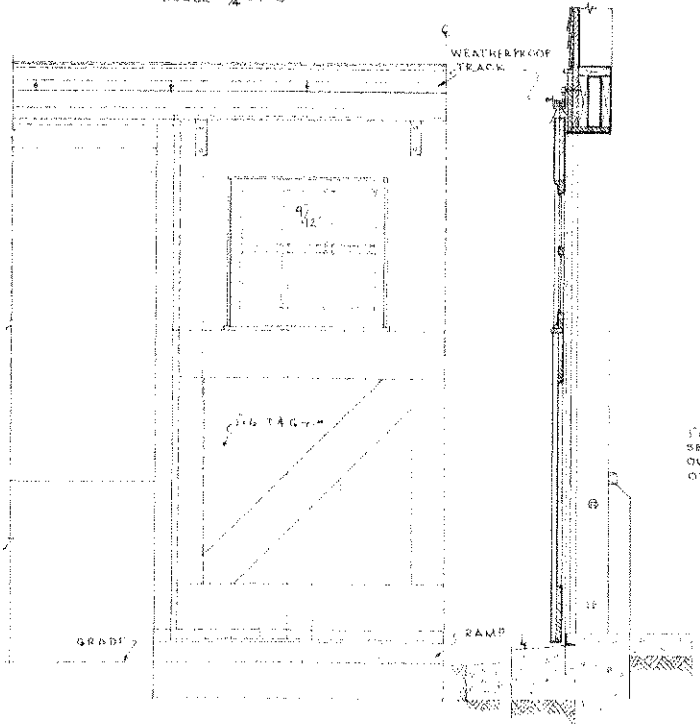

TYPICAL ROLLING DOOR DETAILS
SCALE 3/4"=1'-0"

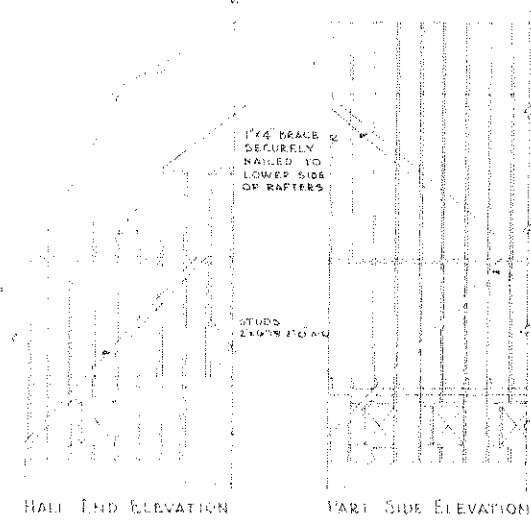

TYPICAL WALL FRAMING
SCALE 3/4"=1'-0"

COOPERATIVE EXTENSION WORK IN
 AGRICULTURE AND HOME ECONOMICS
 STATE OF NORTH DAKOTA
 NORTH DAKOTA AGRICULTURAL COLLEGE
 AND
 U.S. DEPT. OF AGRICULTURE COOPERATING
 EXT. AGR. ENGINEER—FARGO, N. DAK.
DAIRY BARN
 MIDWEST 53
 72501-72502-72503 EX. 5230 SHEET 5077

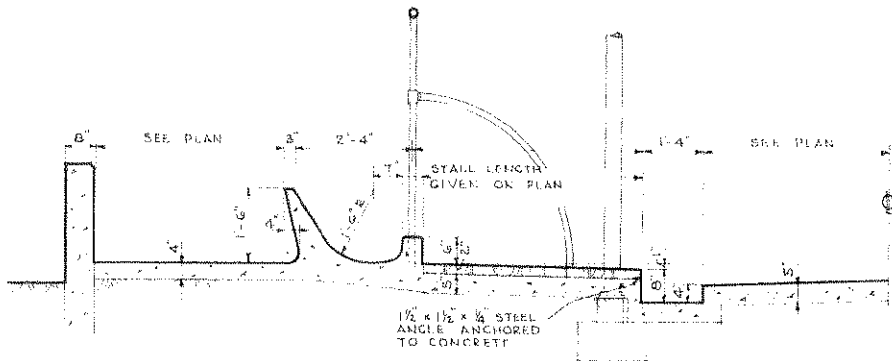

HALF SECTION THRU STALLS FOR FACE OUT ARRANGEMENT
SCALE 1/2" = 1'-0"

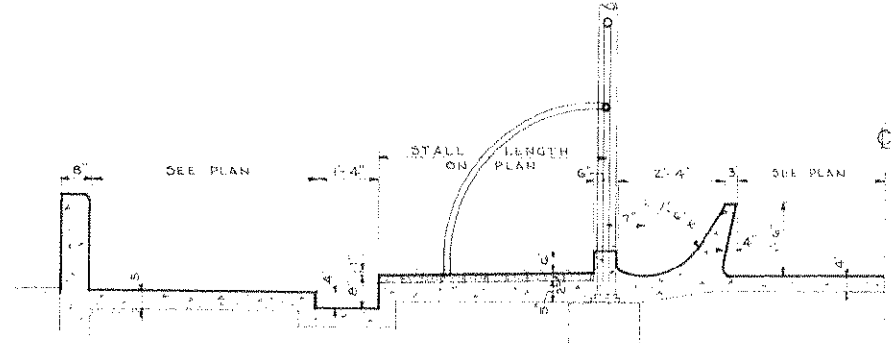

HALF SECTION THRU STALLS FOR FACE IN ARRANGEMENT
SCALE 1/2" = 1'-0"

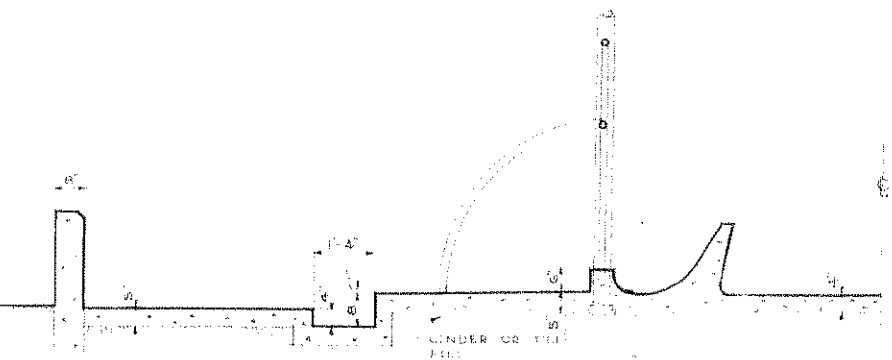

HALF SECTION SHOWING ALTERNATE FLOOR CONSTRUCTION
SCALE 1/2" = 1'-0"

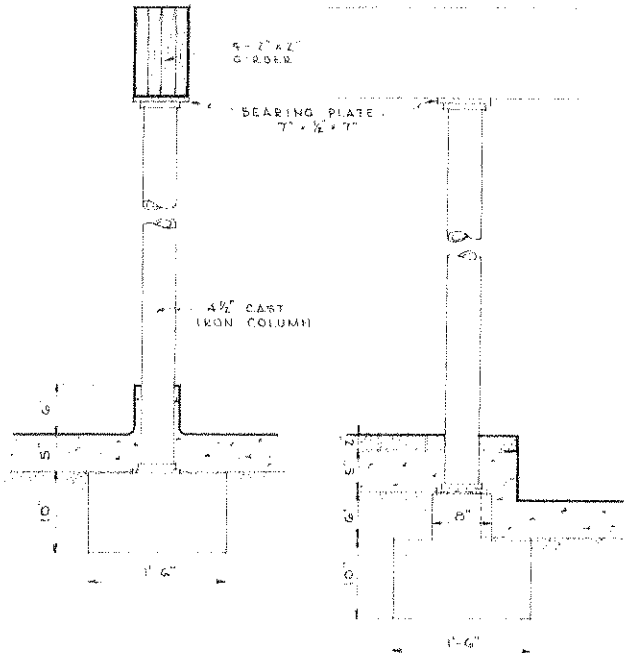

DETAIL FOR COLUMNS IN MANGER CURBS
DETAIL FOR COLUMNS AT GUTTERS

TYPICAL COLUMN DETAILS
SCALE 1" = 1'-0"

COOPERATIVE EXTENSION WORK IN
AGRICULTURE AND HOME ECONOMICS
STATE OF NORTH DAKOTA
NORTH DAKOTA AGRICULTURAL COLLEGE
AND
U. S. DEPT. OF AGRICULTURE COOPERATING
EXT. AGRI. ENGINEER—FARGO, N. DAK.

DAIRY BARN

MIDWEST 58
72301-72310-72321 EX. 5259 SHEET 6 OF 7

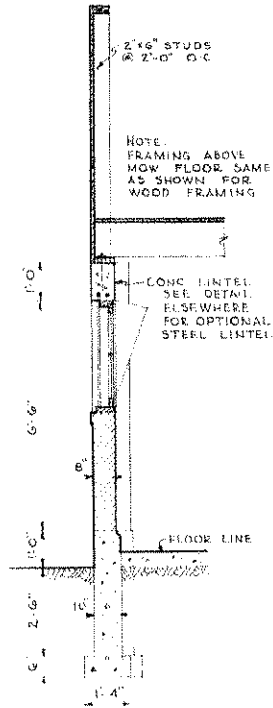

WALL SECTION
SCALE $\frac{3}{8}$ " = 1'-0"



MAKE LENGTH [1" TO] MORE THAN WIDTH OF OPENING. REINFORCE WITH 2-#4 STEEL BARS PLACED AS SHOWN

CONCRETE LINTELS

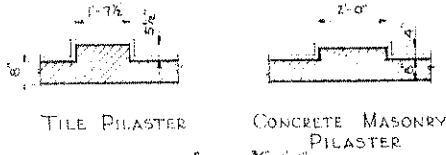

IN TILE AND CONCRETE MASONRY CONSTRUCTION PLACE PILASTERS ON INSIDE OF WALL SPACED @ 12'-0" O.C. MAKE FOUNDATION WALL ACCORDINGLY

PILASTER DETAILS

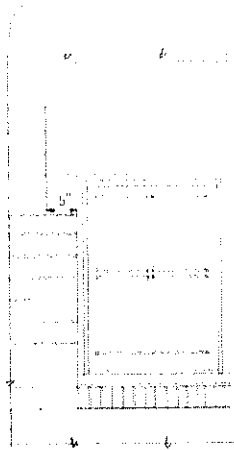

HALF ELEVATION



HORIZONTAL SECTION

TYPICAL WINDOW DETAILS
SCALE $\frac{3}{4}$ " = 1'-0"

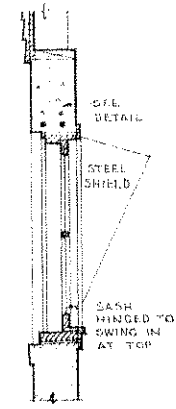

VERTICAL SECTION

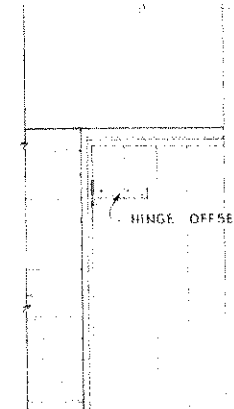

PART ELEVATION



HEAD

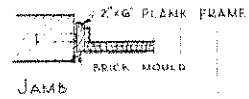

JAMB

STEEL LINTELS
STEEL LINTELS AS SHOWN ABOVE SHALL CONSIST OF 2 ANGLES 2 1/2" x 3 1/2" x 5/8" AND SHALL BE EQUAL IN LENGTH TO THE WIDTH OF THE OPENING PLUS 10"

TYPICAL DOOR DETAILS
SCALE $\frac{3}{4}$ " = 1'-0"

TYPICAL CONCRETE OR TILE MASONRY DETAILS

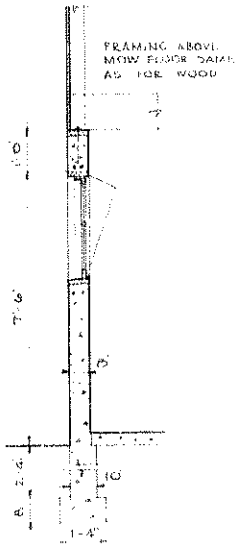

TYPICAL WALL SECTION
SCALE $\frac{3}{8}$ " = 1'-0"

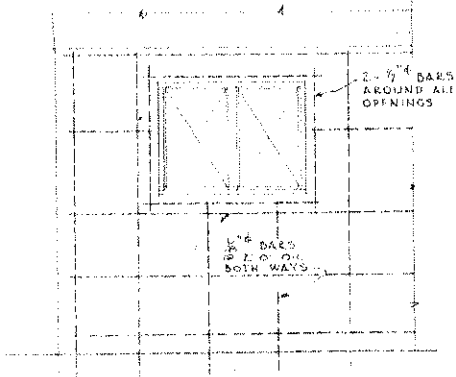

TYPICAL WALL ELEVATION
SCALE $\frac{3}{4}$ " = 1'-0"

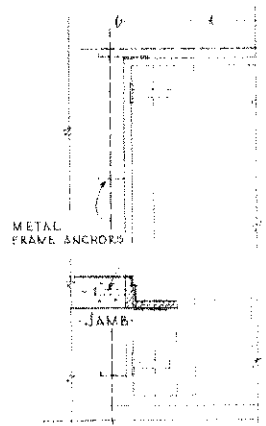

TYPICAL DOOR DETAILS
SCALE $\frac{3}{4}$ " = 1'-0"



HEAD

ON ALL OPENINGS THE PLANK FRAME SHALL BE MADE FULL 8" WIDE AND TACKED IN PLACE IN THE FORMS BEFORE THE CONCRETE IS PLACED.

TYPICAL DETAILS FOR MONOLITHIC CONCRETE WALL

COOPERATIVE EXTENSION WORK IN
AGRICULTURE AND HOME ECONOMICS
STATE OF NORTH DAKOTA
NORTH DAKOTA AGRICULTURAL COLLEGE
AND
U.S. DEPT. OF AGRICULTURE COOPERATING
EXT. AGR'L. ENGINEER-FARGO, N. DAK.
DAIRY BARN
NORTHWEST '33
72301-72311-72321 EX. 5260 SHEET 7 of 7