

EAST ELEVATION
SCALE $\frac{1}{8}'' = 1'-0''$

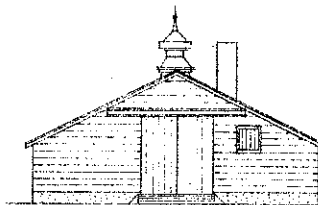

NORTH ELEVATION
SCALE $\frac{1}{8}'' = 1'-0''$

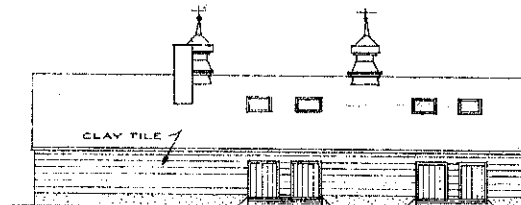

WEST ELEVATION
SCALE $\frac{1}{8}'' = 1'-0''$

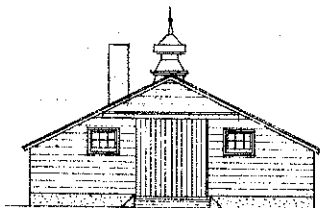

SOUTH ELEVATION
SCALE $\frac{1}{8}'' = 1'-0''$

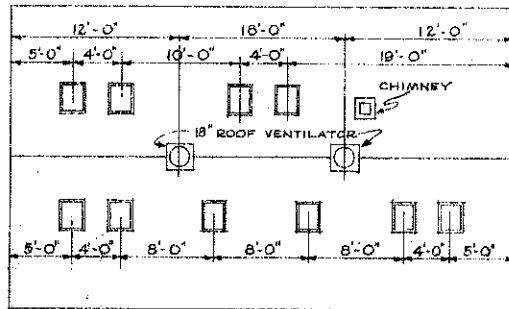

ROOF PLAN
SCALE $\frac{1}{8}'' = 1'-0''$

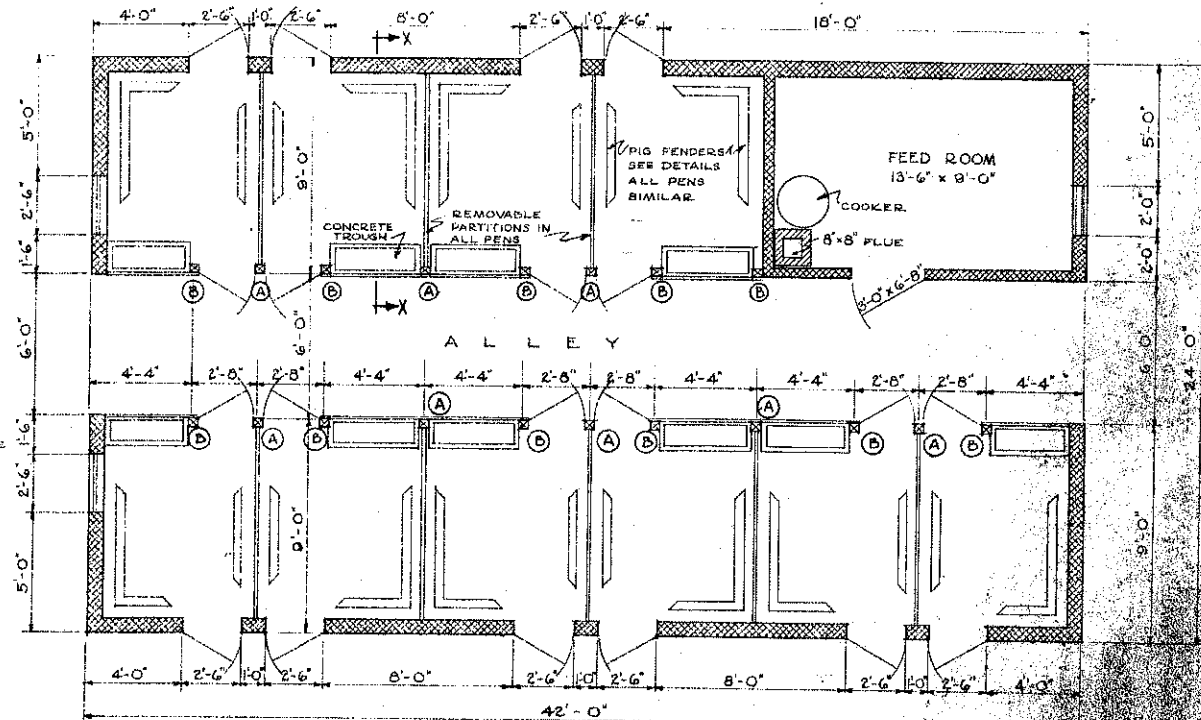

FLOOR PLAN
SCALE $\frac{1}{4}'' = 1'-0''$

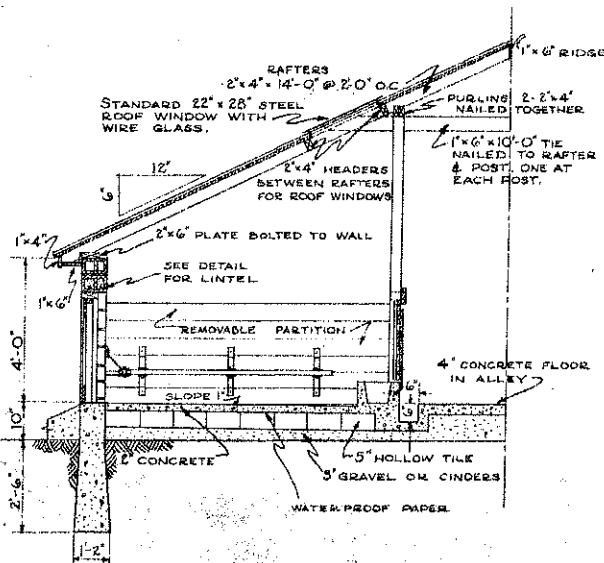

HALF CROSS SECTION
SCALE $\frac{1}{8}'' = 1'-0''$

COOPERATIVE EXTENSION WORK IN
 AGRICULTURE AND HOME ECONOMICS
 NORTH DAKOTA STATE COLLEGE
 U.S. GOVERNMENT PRINTING OFFICE
GABLE ROOF HOG HOUSE
 LOWEST 716-311X 3282 SHEET 10-3

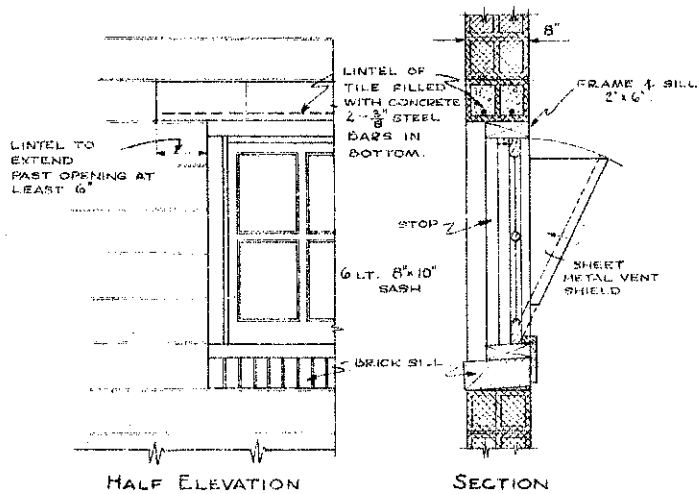

WINDOW DETAILS

SCALE 1" = 1'-0"

SMALL SCOOP DOOR IN FEED ROOM SIMILAR EXCEPT WITH HINGED BATTEN DOOR.

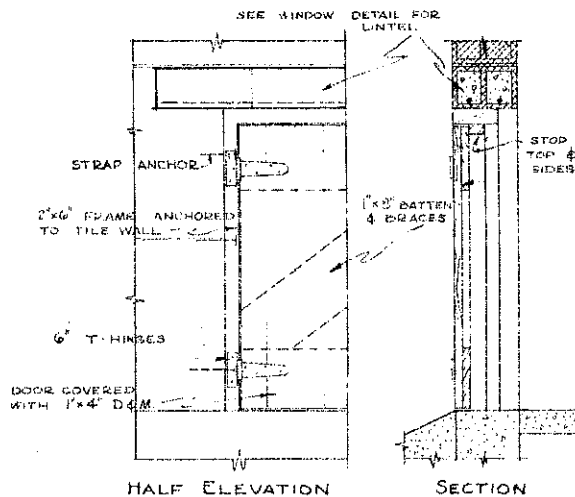

HOG DOOR DETAILS

SCALE 1" = 1'-0"

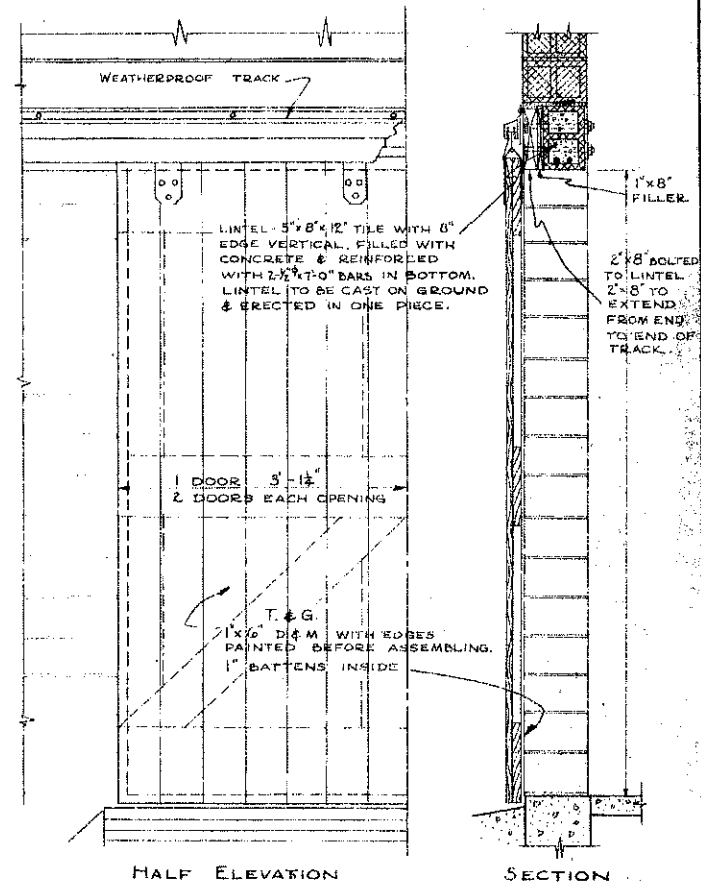

ALLEY DOOR DETAILS

SCALE 1" = 1'-0"

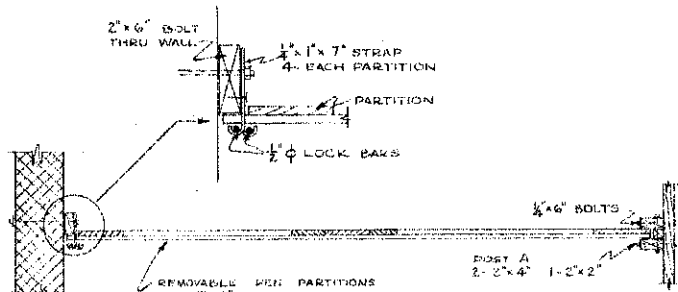

SECTION X-X THRU PEN

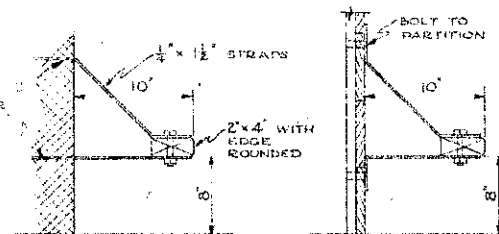

PIG FENDER DETAILS

SCALE 1/2" = 1'-0"

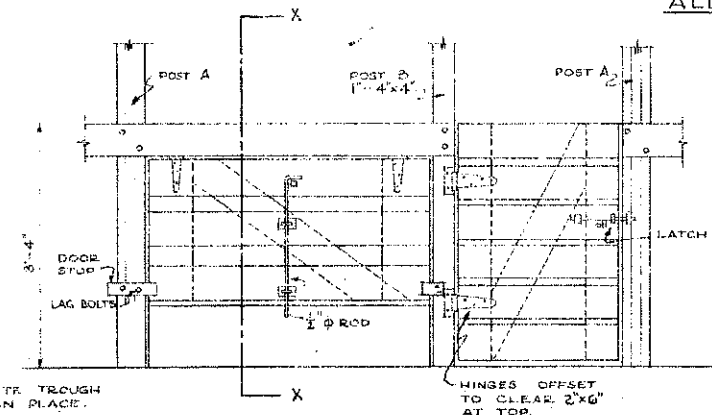

FRONT ELEVATION OF PEN

PEN DETAILS

SCALE 1/2" = 1'-0"

COOPERATIVE EXTENSION WORK IN
 AGRICULTURE AND HOME ECONOMICS
 STATE OF NORTH DAKOTA
 NORTH DAKOTA AGRICULTURAL COLLEGE
 AND
 U. S. DEPT. OF AGRICULTURE COOPERATING
 EXT. AGRI. ENGINEER - FARGO, N. DAK.

GABLE ROOF HOG HOUSE

MIDWEST 72613-33 EX. 5283 SHEET 2 of 3

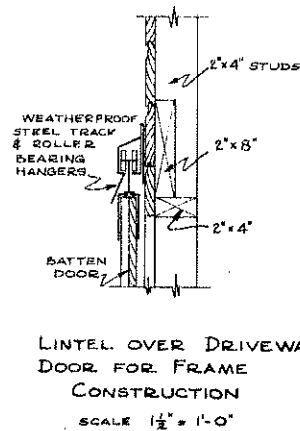
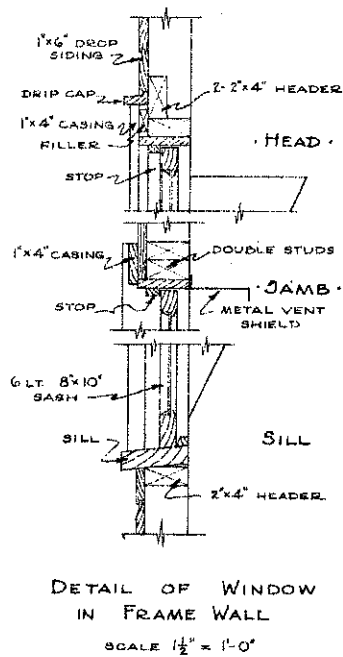
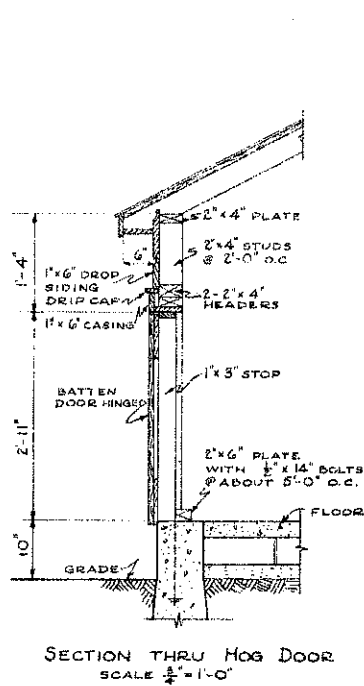

ALTERNATE DETAILS FOR FRAME WALL CONSTRUCTION

DETAILS NOT SHOWN TO BE SAME AS FOR MASONRY