

WEST ELEVATION  
SCALE  $\frac{1}{8}'' = 1'-0''$

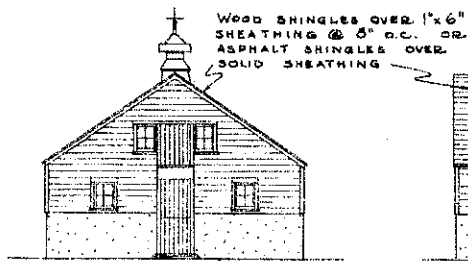

END ELEVATION  
SCALE  $\frac{1}{8}'' = 1'-0''$

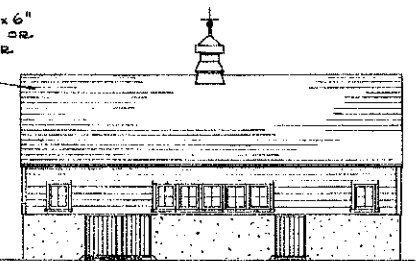

EAST ELEVATION  
SCALE  $\frac{1}{8}'' = 1'-0''$

ALL WINDOWS  
4 LT. 8' x 12' SASH

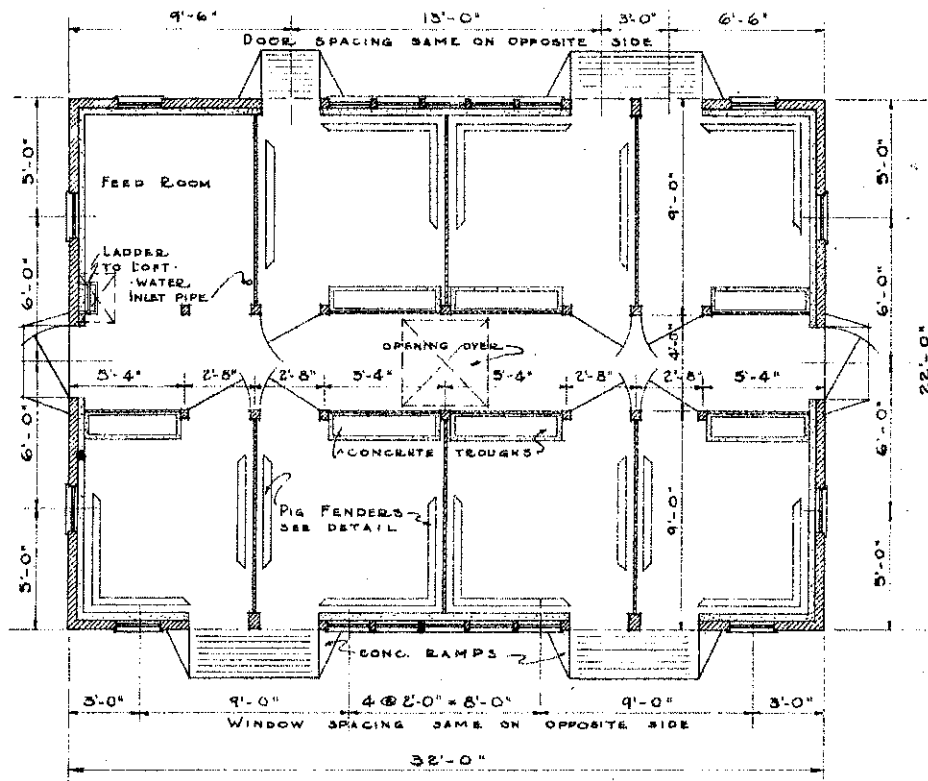

FLOOR PLAN  
SCALE  $\frac{1}{4}'' = 1'-0''$

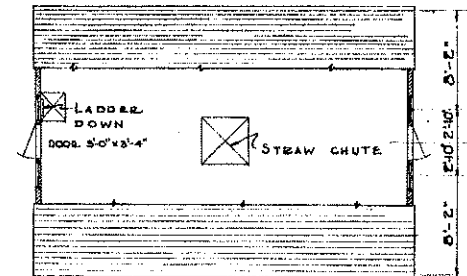

LOFT PLAN  
SCALE  $\frac{1}{8}'' = 1'-0''$

COOPERATIVE EXTENSION WORK IN  
AGRICULTURE AND HOME ECONOMICS  
STATE OF NORTH DAKOTA  
NORTH DAKOTA AGRICULTURAL COLLEGE  
AND  
U. S. DEPT. OF AGRICULTURE COOPERATING  
EXT. AGR'L. ENGINEER - FARGO, N. DAK.  
**STRAW-LOFT HOG HOUSE**  
MINWEST 72627 31EX 5265 SHEET 2 OF 2

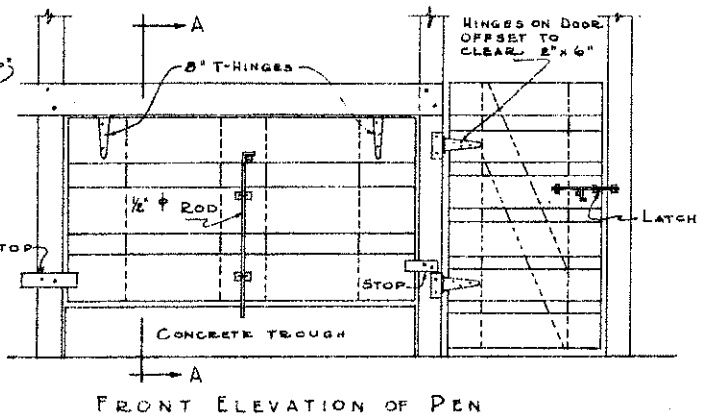
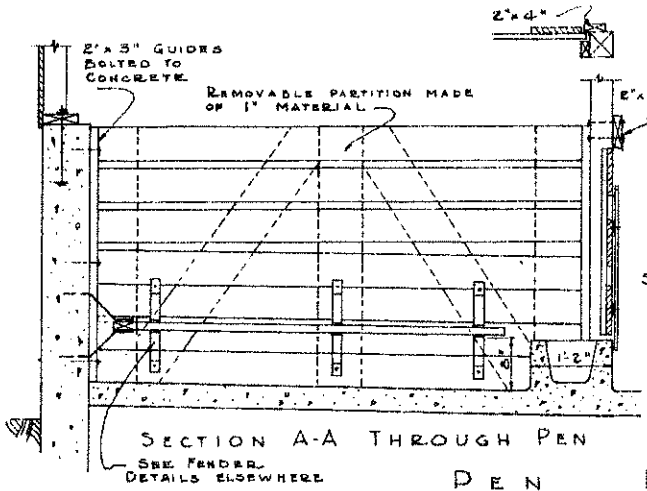
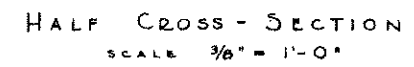
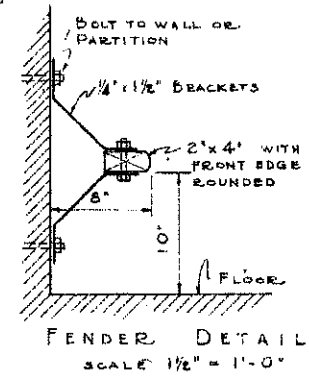
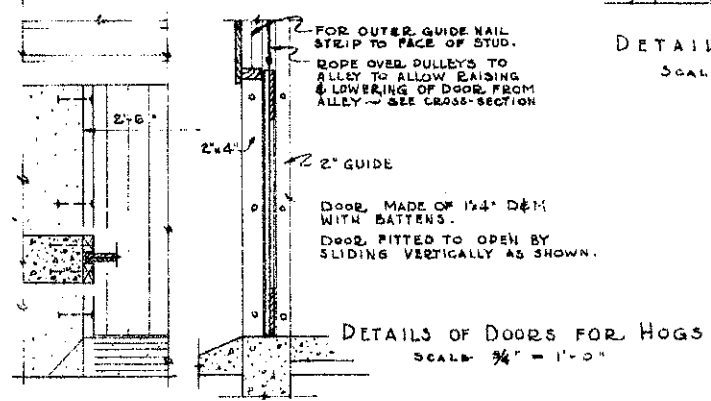
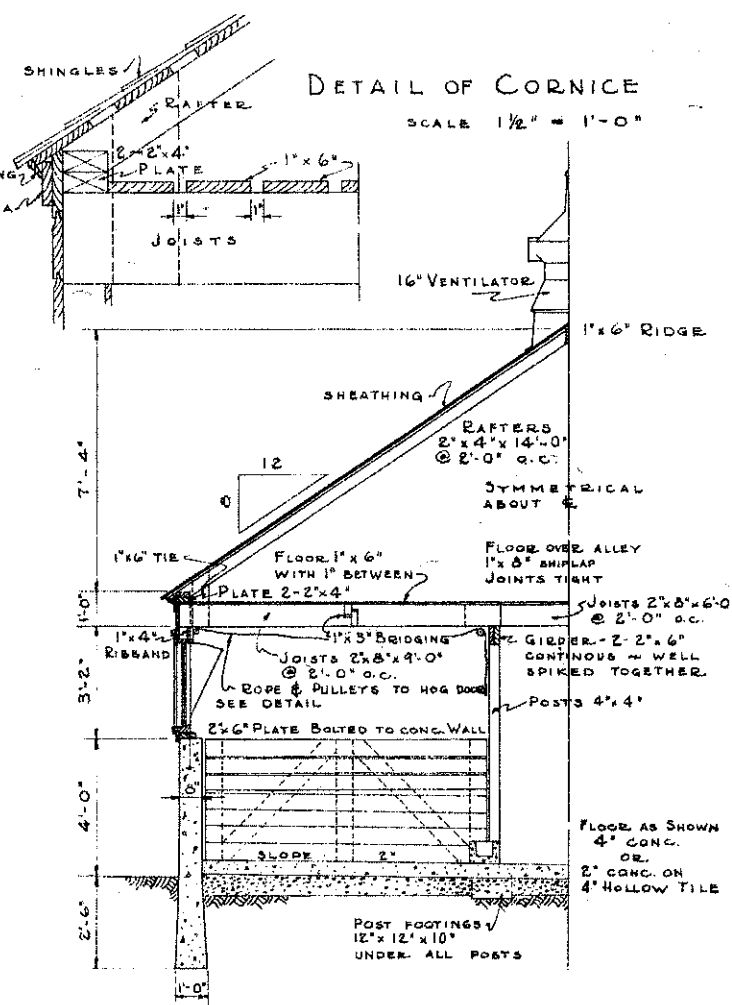
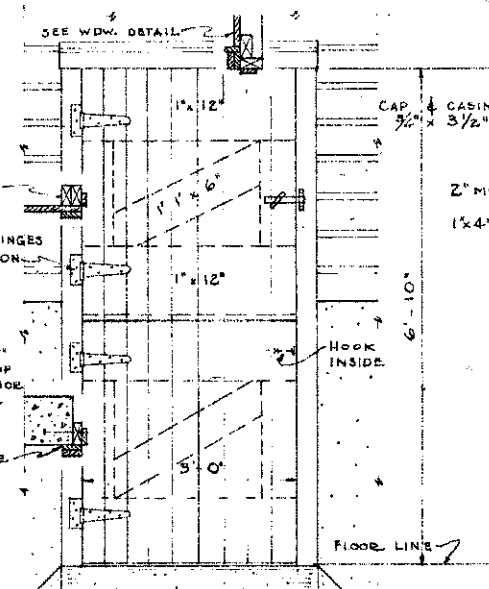
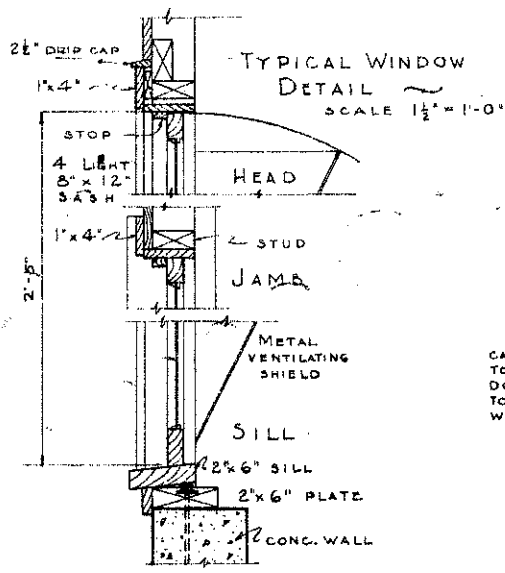

COOPERATIVE EXTENSION WORK IN  
**AGRICULTURE AND HOME ECONOMICS**  
 STATE OF NORTH DAKOTA  
 NORTH DAKOTA AGRICULTURAL COLLEGE  
 AND  
 U.S. DEPT. OF AGRICULTURE COOPERATING  
 EXT. AGR'L. ENGINEER- FARGO, N. DAK.  
**STRAWL OF T HOG HOUSE**  
 H. B. WEST 27671-133 11 x 22 8 1/2 SHEET 2 OF 2