

EAST ELEVATION

SCALE 3/8" = 1'-0"

NOTE:
ROOFING MAY BE WOOD SHINGLES LAID 45° TO WEATHER, OR 1/2" SHEATHING SPACED 8" O.C. OR PREPARED ROOFING LAID ON SOLID SHEATHING

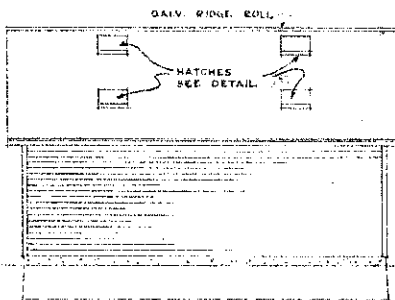

WEST ELEVATION

SCALE 3/8" = 1'-0"

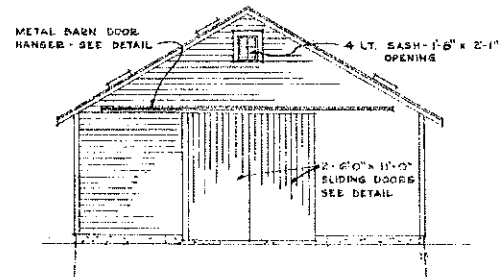

NORTH AND SOUTH ELEVATION

SCALE 1/8" = 1'-0"

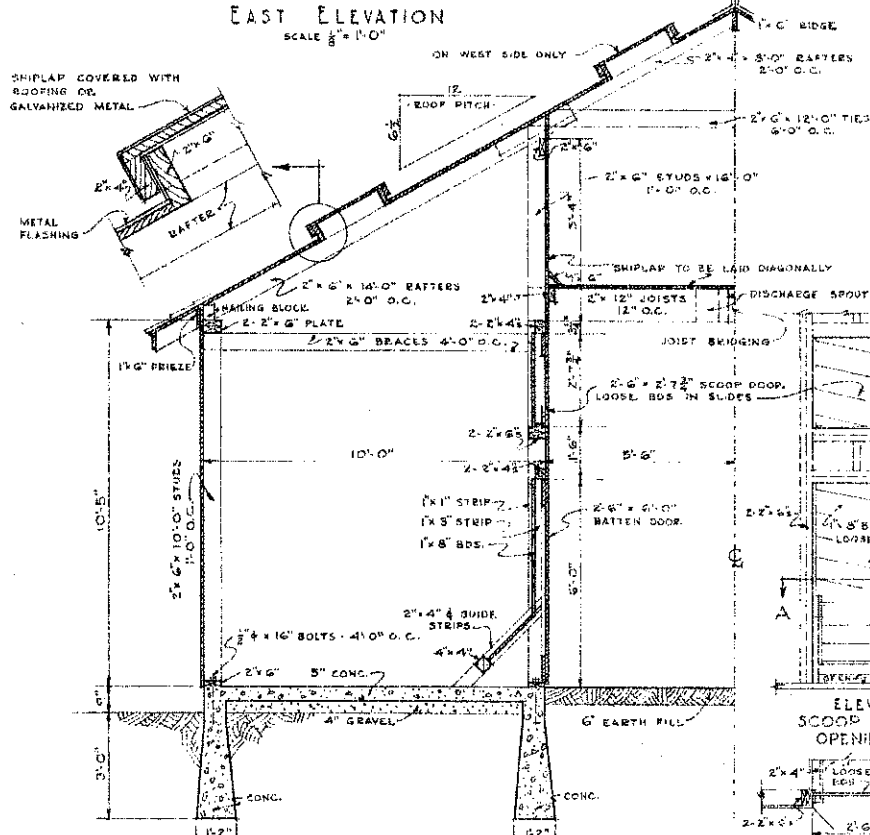

ONE-HALF CROSS SECTION

SCALE 3/8" = 1'-0"

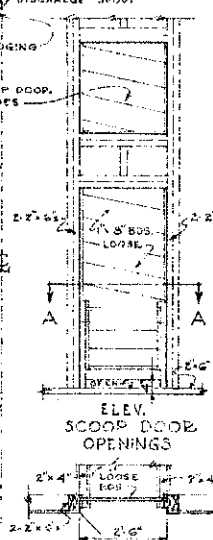

PLAN A-A

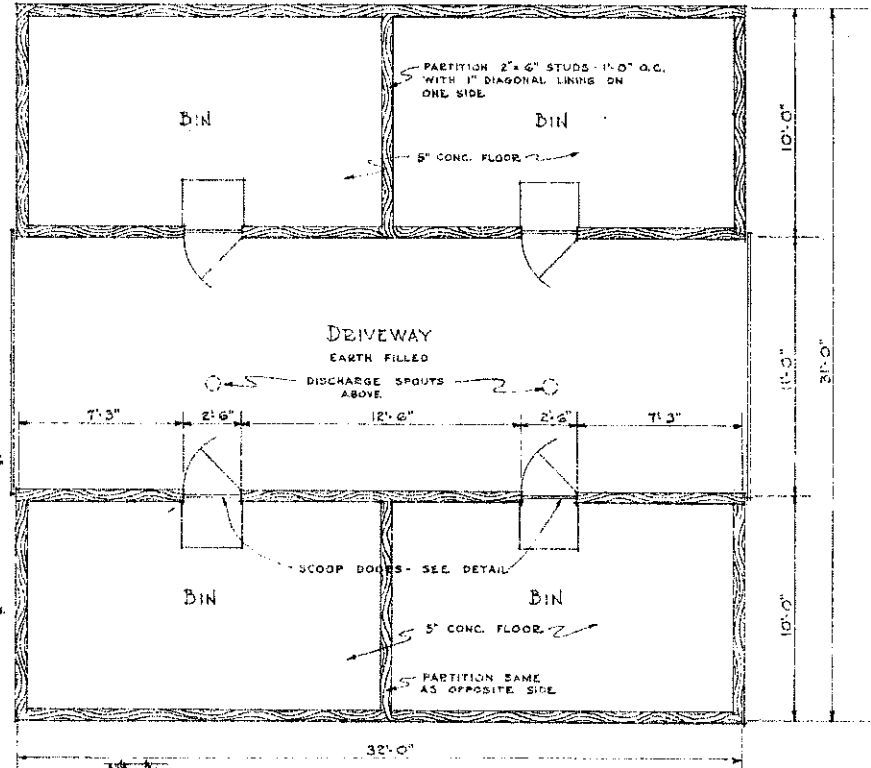

FLOOR PLAN

SCALE 1/4" = 1'-0"

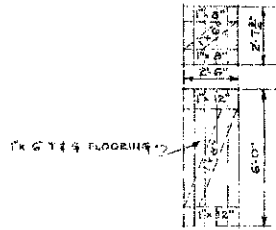

ELEVATION OF SCOOP DOORS

SCALE 1/4" = 1'-0"

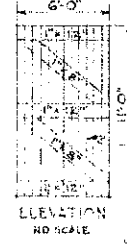

SLIDING DOOR DETAILS

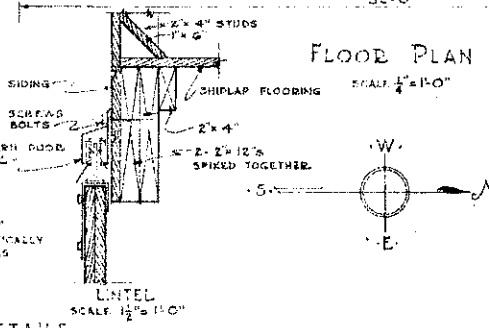

LINTEL

SCALE 1/2" = 1'-0"

COOPERATIVE EXTENSION WORK IN AGRICULTURE AND HOME ECONOMICS
STATE OF NORTH DAKOTA
NORTH DAKOTA AGRICULTURAL COLLEGE
AND
U.S. DEPT. OF AGRICULTURE COOPERATING
EXT. AG'N. ENGINEER - FARGO, N. DAK.
5000 BU. GRAIN BIN
MIDWEST 73-114-133 EX. 5328 SHEET 1 OF 1