

PLYWOOD CUT-OUTS

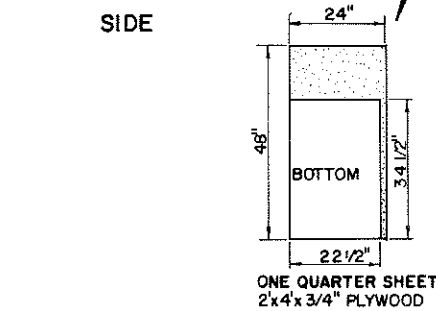

ONE QUARTER SHEET 2'x4'x3/4\"/>

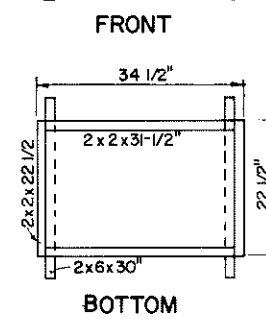
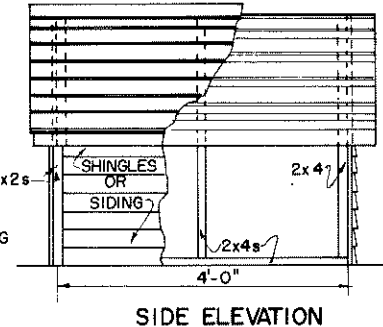
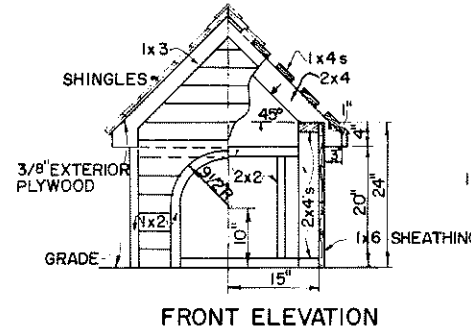
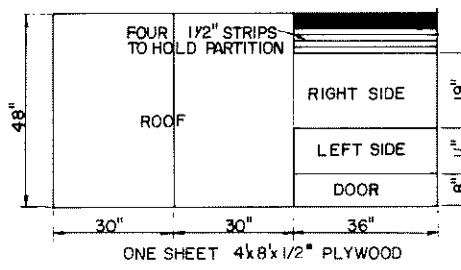
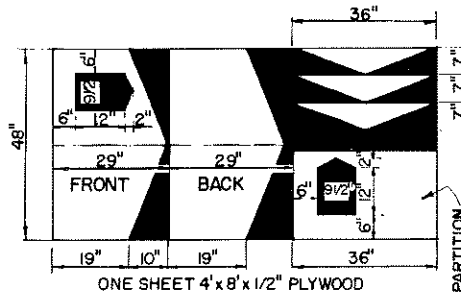
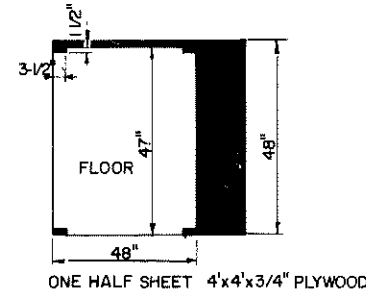
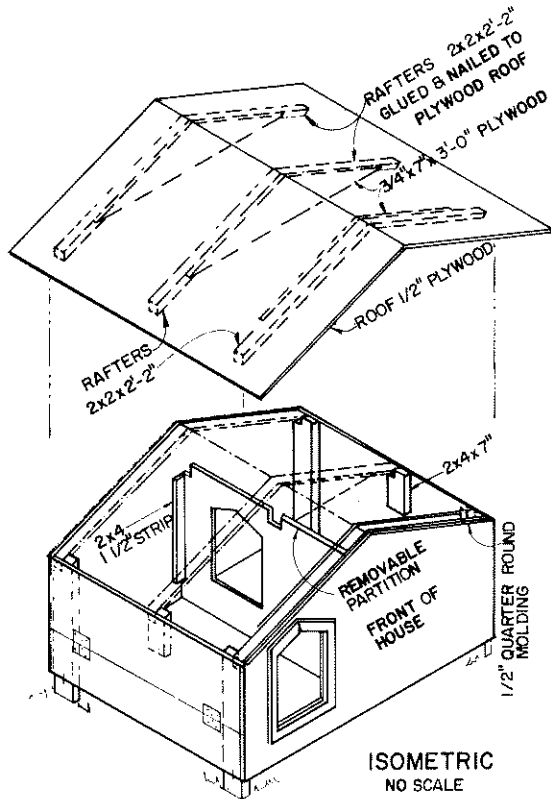

COOPERATIVE EXTENSION WORK IN AGRICULTURE AND HOME ECONOMICS

AND UNITED STATES DEPARTMENT OF AGRICULTURE COOPERATING

**DOG HOUSES**  
TYPES A, B, & C

USDA '77	6278	SHEET 1 OF 1
----------	------	--------------

*Rev. '87*

BASED ON: AUBURN UNIV. PLAN NO E-302 PLANS FROM NORTH CAROLINA STATE UNIV. & CORNELL UNIV.