

FRONT ELEVATION

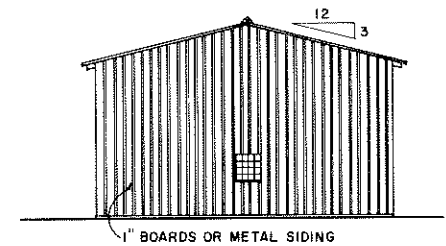

END ELEVATION

NOTE: CONSULT LOCAL BUILDING CODE AUTHORITIES BEFORE STARTING CONSTRUCTION.

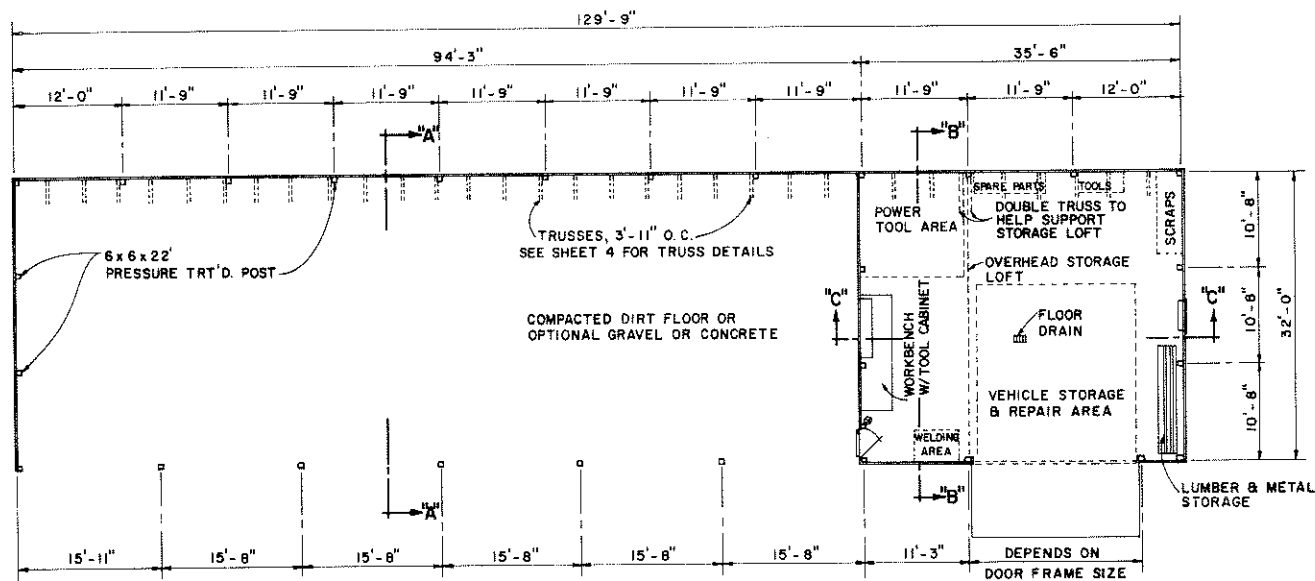

FLOOR PLAN

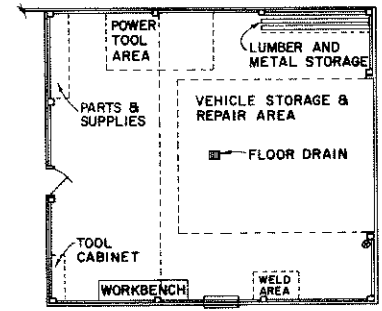

OPTIONAL SHOP LAYOUT

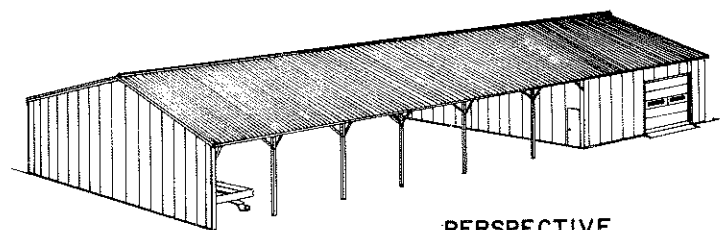

PERSPECTIVE
NO SCALE

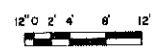

SCALE: UNLESS OTHERWISE NOTED

COOPERATIVE EXTENSION WORK IN
AGRICULTURE AND HOME ECONOMICS

AND
UNITED STATES DEPARTMENT OF AGRICULTURE COOPERATING

MACHINERY SHED

KY. '77	6287	SHEET 1 OF 4
---------	------	--------------

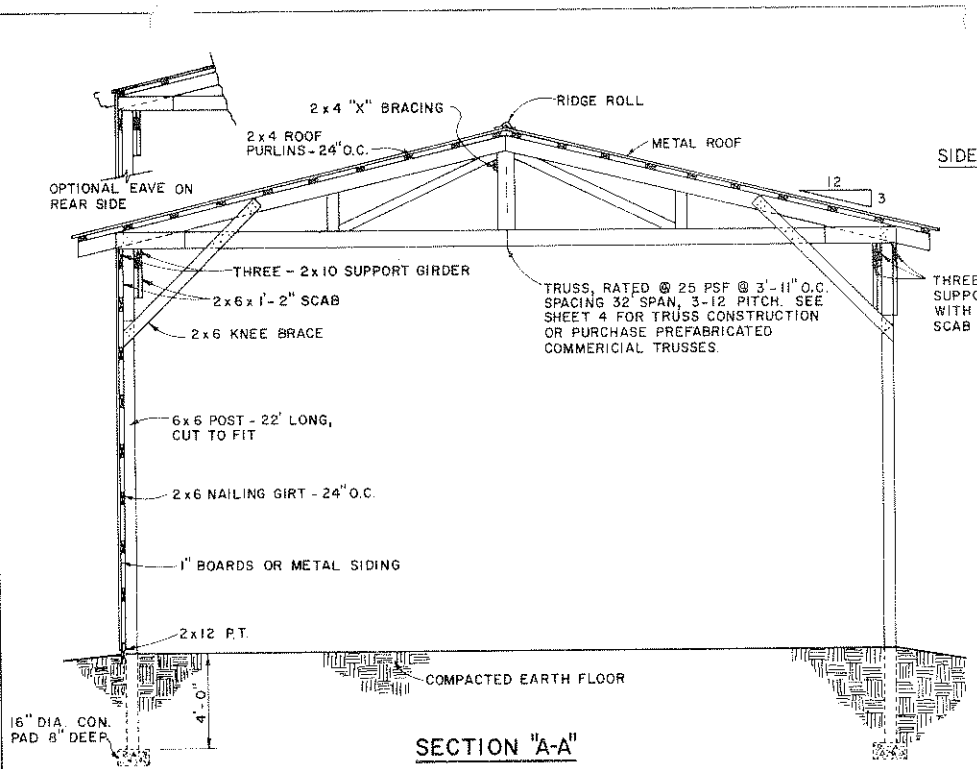

SECTION "A-A"

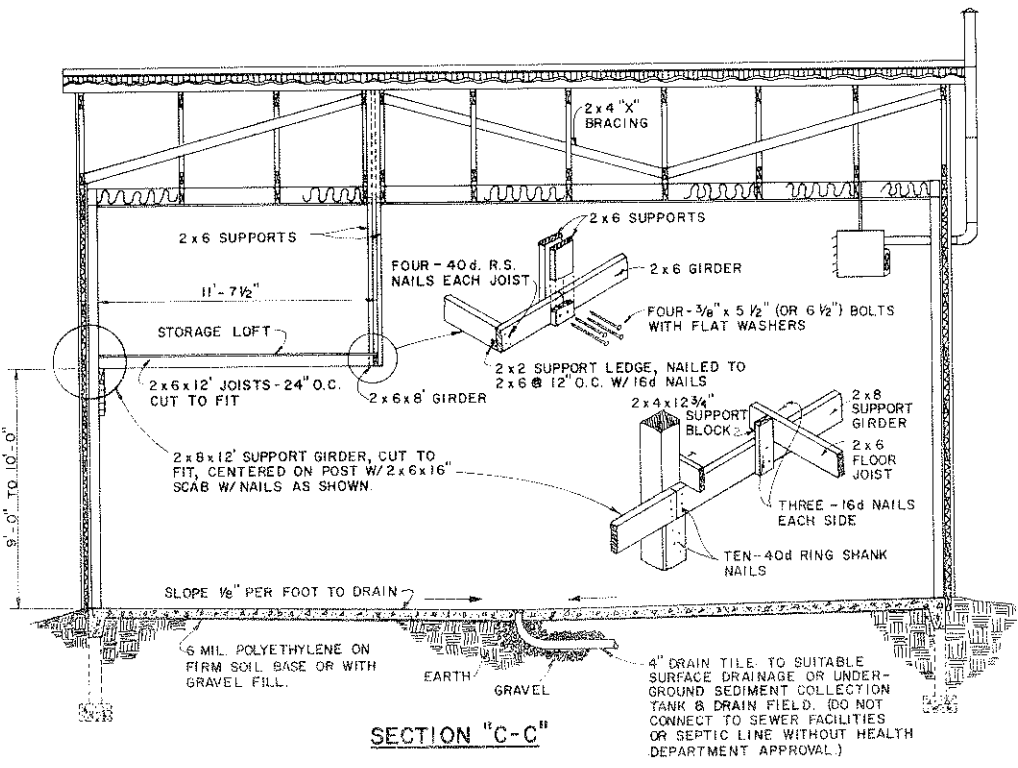
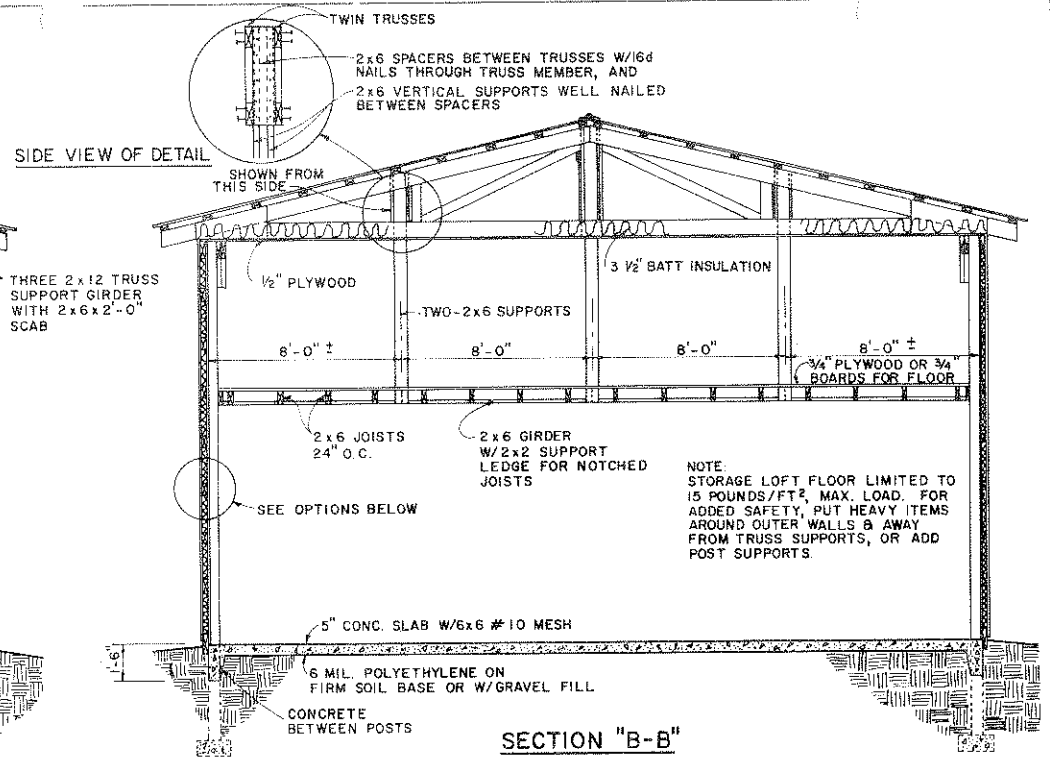

SECTION "C-C"

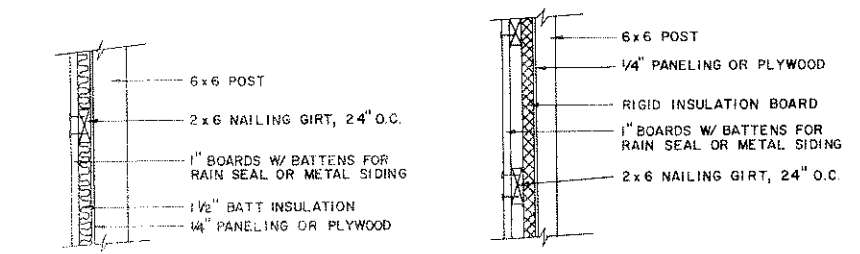

SIDE WALL CONSTRUCTION OPTIONS

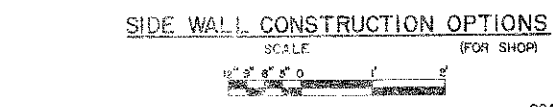

NOTE: ANOTHER OPTION IS TO FRAME IN A 2x4 STUD WALL BETWEEN THE POSTS & USE 3 1/2" BATT INSULATION & PANELING, DRYWALL OR PLYWOOD COVERING.

SCALE: UNLESS OTHERWISE NOTED

COOPERATIVE EXTENSION WORK IN AGRICULTURE AND HOME ECONOMICS

AND UNITED STATES DEPARTMENT OF AGRICULTURE COOPERATING

MACHINERY SHED

KY '77	6287	SHEET 2 OF 4
--------	------	--------------

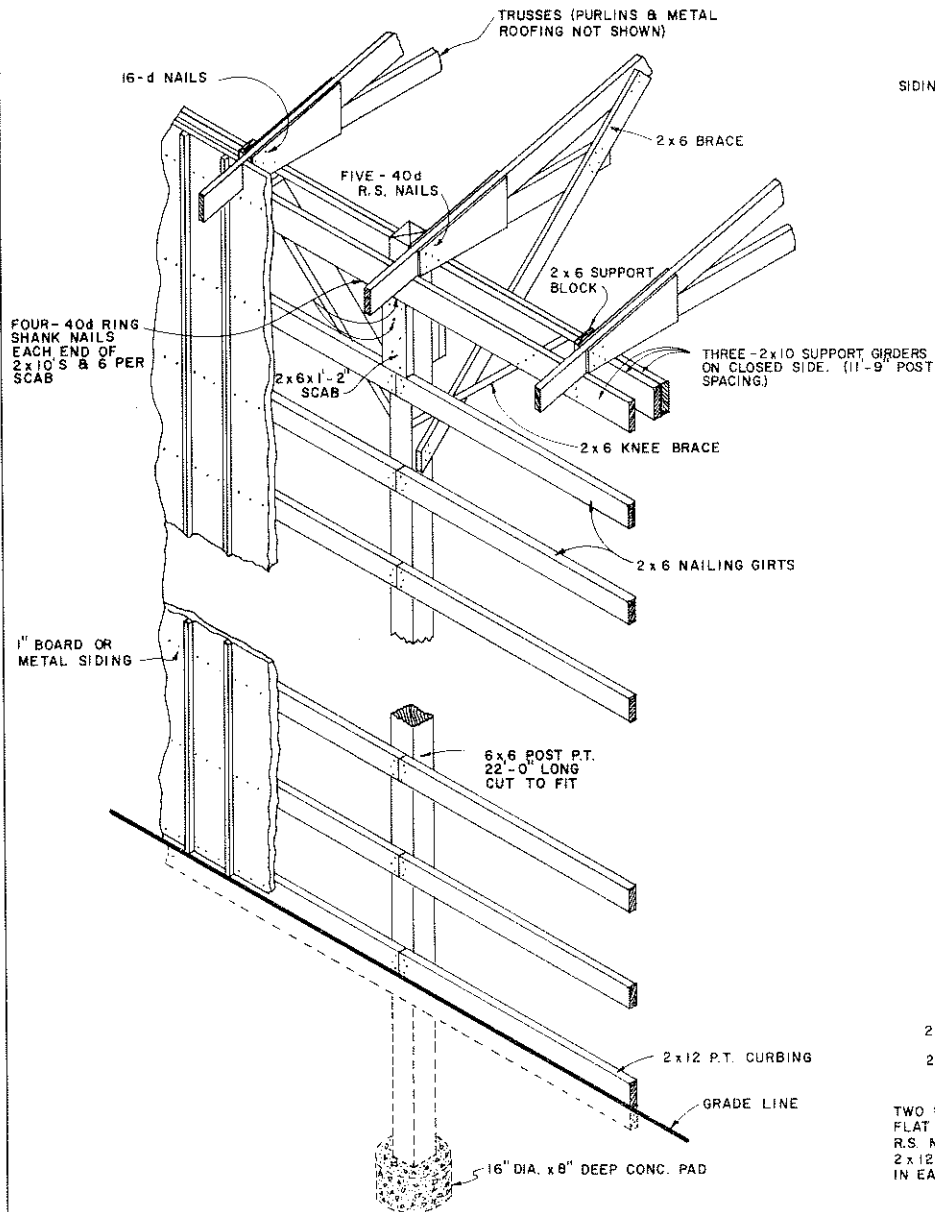

SIDEWALL CONSTRUCTION DETAIL
(FOR SHED)
NO SCALE

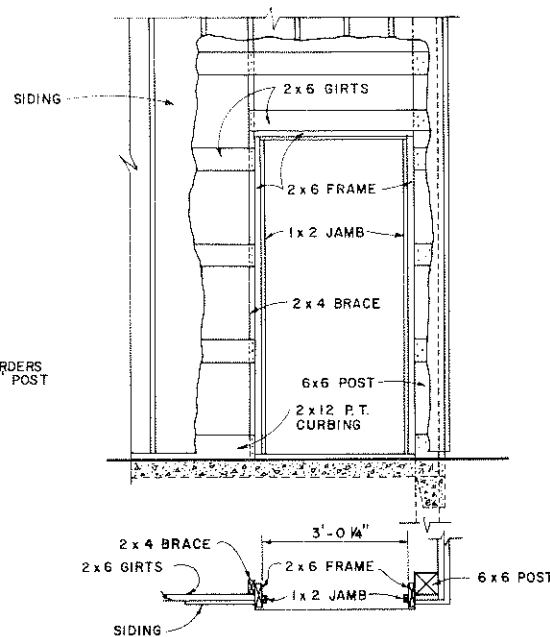

DOOR FRAMING DETAIL
NO SCALE

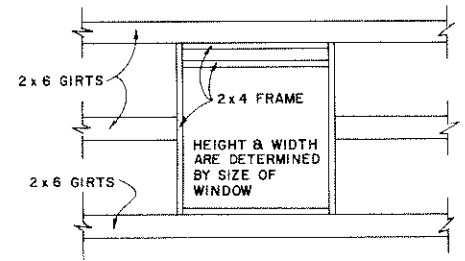

WINDOW FRAMING DETAIL

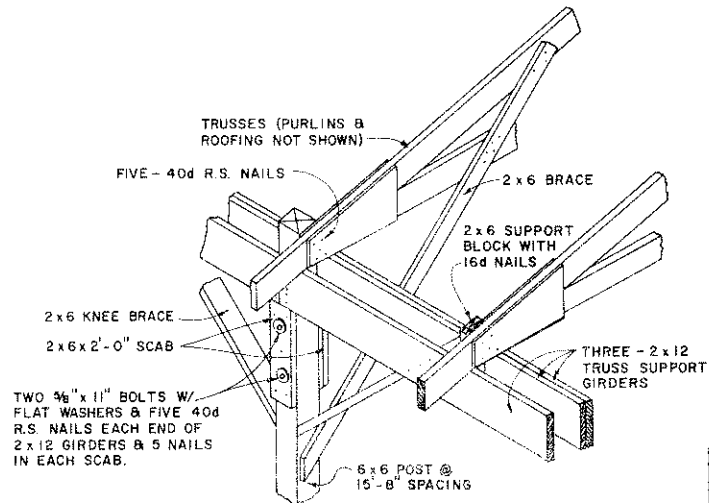

POST CONSTRUCTION DETAIL
(ENTRY SIDE OF SHED)



SCALE: UNLESS OTHERWISE NOTED

COOPERATIVE EXTENSION WORK IN
AGRICULTURE AND HOME ECONOMICS

AND
UNITED STATES DEPARTMENT OF AGRICULTURE COOPERATING

MACHINERY SHED

KY. '77 6287 SHEET 3 OF 4

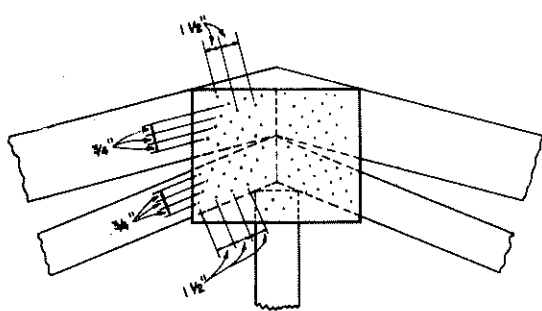

EXAMPLE NAILING PATTERN

(USE SIMILAR PATTERN FOR OTHER JOISTS)
SCALE:

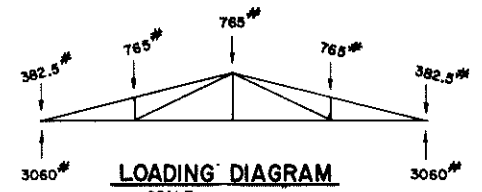
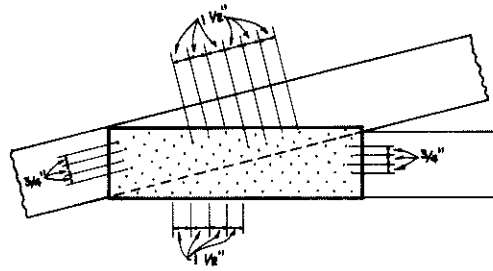
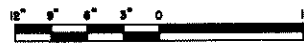

DESIGN LOADS @ 4' SPACING
 ① ROOF, WIND, SNOW = 25 PSF.
 ON TOP CHORD.
 ② NONE ON BOTTOM CHORD
 EXCEPT FOR LOFT.

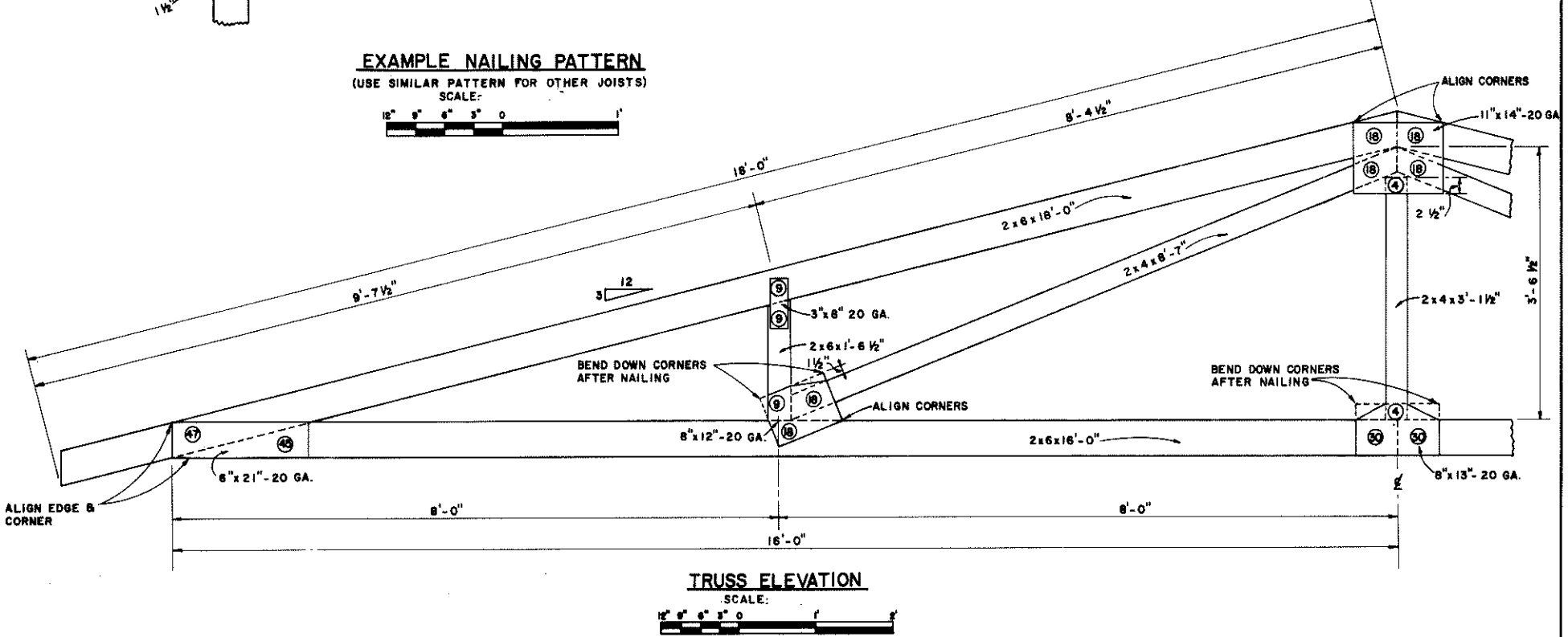

TRUSS ELEVATION

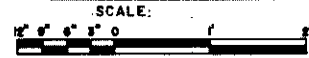

SPECIFICATIONS FOR NAIL-ON METAL-GUSSET-PLATE TRUSS CONSTRUCTION:

- LUMBER SHALL BE DRESSED, KILN DRY, STANDARD OR CONSTRUCTION GRADE DOUG. FIR, NO. 1 OR 2 SOU. YEL. PINE, OR EQUIVALENT.
- GUSSET PLATES SHALL BE GALVANIZED STEEL, 18 OR 20 GAUGE AS SPECIFIED, ONE ON BOTH SIDES OF EACH JOINT. PLATES MAY BE PRE-PUNCHED OR BLANK (DRIVE NAILS RIGHT THROUGH BLANK PLATE).
- NAILS SHALL BE 1-1/2", 11 GAUGE, SCREW-SHANK, HARDENED, PALLET-TYPE NAIL.
- NUMBER OF NAILS DRIVEN THROUGH GUSSET PLATE INTO EACH SIDE OF EACH MEMBER IS SHOWN BY NUMERALS IN CIRCLE AT EACH JOINT. DRIVE ALL NAILS SNUG AGAINST THE METAL PLATE.
- ALIGN GUSSET PLATE OVER JOINT AS SHOWN ON TRUSS DIAGRAM. BEGIN NAILING IN CENTER OF GUSSET PLATE AND PROGRESS OUTWARDS TO ELIMINATE WRINKLES.
- SPACE NAILS EVENLY OVER GUSSET PLATE ABOUT 1-1/2" APART ALONG GRAIN OF WOOD AND 3/4" APART ACROSS GRAIN IN STAGGERED PATTERN AS SHOWN AT THE RIGHT FOR MAXIMUM STRENGTH AND NO SPLITTING.
- USE A JIG TO KEEP TRUSS MEMBERS ALIGNED AND PROVIDE FIRM SUPPORT UNDERNEATH FOR NAILING. BUTT ALL JOINTS TOGETHER TIGHTLY. A FEW NAILS IN EACH JOINT SHOULD COME WITHIN 3/8 TO 1/2 INCH OF JOINT BUTT-ENDS AND EDGES TO HOLD METAL PLATE FLAT.
- DO NOT FABRICATE ANY JOINT HAVING A KNOT OR OTHER WOOD IMPERFECTION UNDER OR ADJACENT TO GUSSET PLATE.
- HANDLE TRUSS WITH CARE WHEN ROTATING TO ATTACH OPPOSITE-SIDE GUSSET PLATES.



BILL OF MATERIALS

ITEM	NO.	SIZE	QUANTITY
Top Chord	2	2 x 6 x 18'	36 bd.ft.
Bottom Chord	2	2 x 6 x 16'	32 bd.ft.
Diagonals	2	2 x 4 x 1'-6 1/2"	2.1 bd.ft.
	2	2 x 4 x 8'-7"	11.4 bd.ft.
	1	2 x 4 x 3'-1 1/2"	2.1 bd.ft.
			83.6 bd.ft.
Metal Plates	4	6 x 21 - 20 GA	
	4	8 x 12 - 20 GA	
	4	3 x 8 - 20 GA	36" x 48" - 20 GA
	2	11 x 14 - 20 GA	
	2	8 x 13 - 20 GA	
Nails	900	1 1/2", 11 GA., Screw Shank	6 lbs.

NOTE:
 DETAILS OF WOOD GUSSETS
 AND NAILING NOT SHOWN.
 METAL GUSSETS ARE PRE-
 FERRED.

COOPERATIVE EXTENSION WORK IN
 AGRICULTURE AND HOME ECONOMICS

AND
 UNITED STATES DEPARTMENT OF AGRICULTURE COOPERATING

MACHINERY SHED

KY. '77	6287	SHEET 4 OF 4
---------	------	--------------