

**NOTES:**

- 1) ALL CONNECTIONS ARE TO BE WELDED.
- 2) RUBBER MATTING MAY BE USED OVER METAL FLOORING.
- 3) DIMENSIONAL INFORMATION FOR BUCKET ATTACHMENT WILL VARY DUE TO TYPE/SIZE OF BUCKET USED.

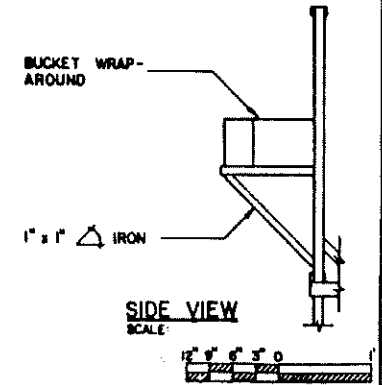

**LATCH MECHANISM DETAIL**  
FULL SCALE

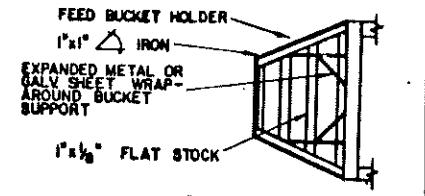
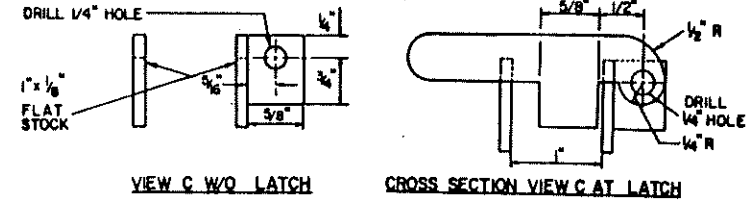
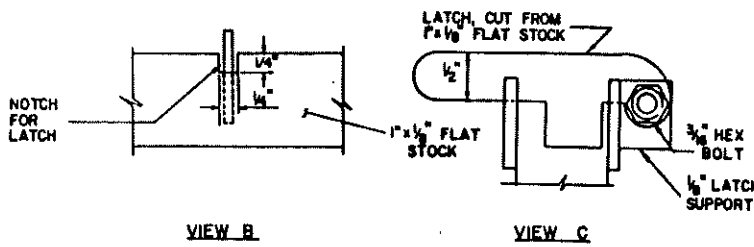
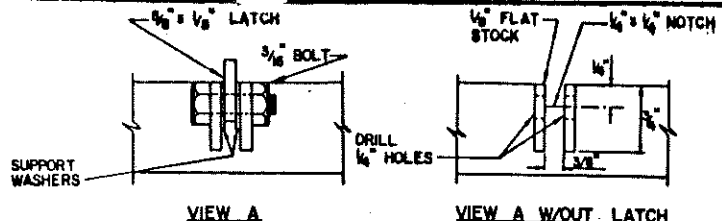
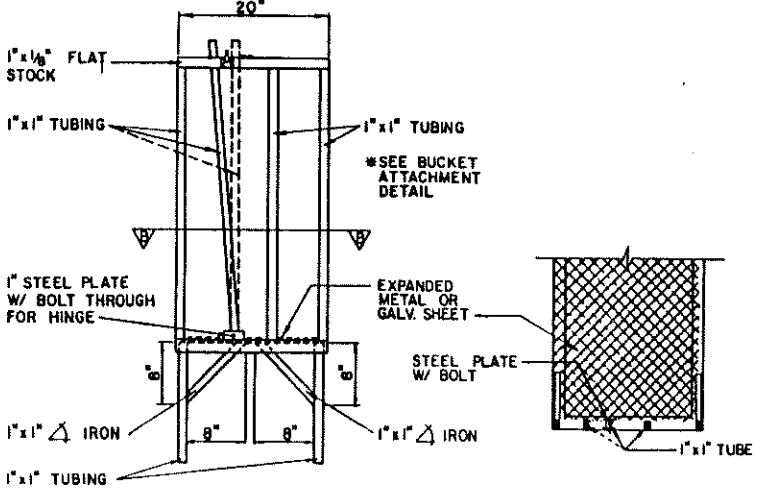
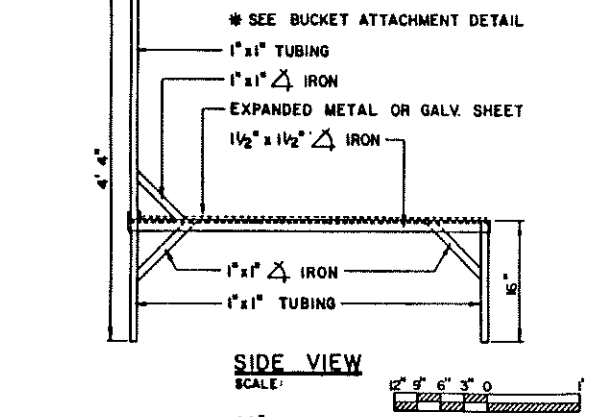
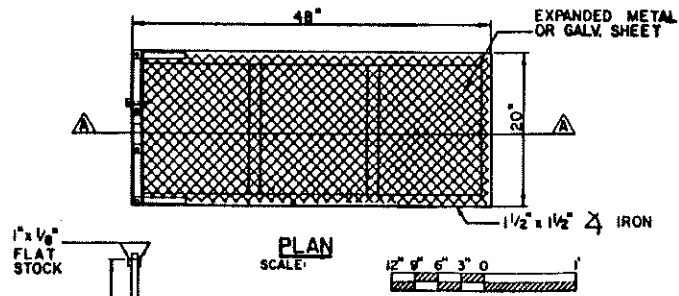
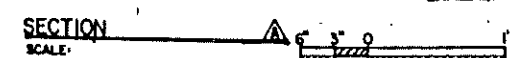
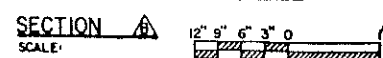
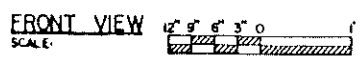
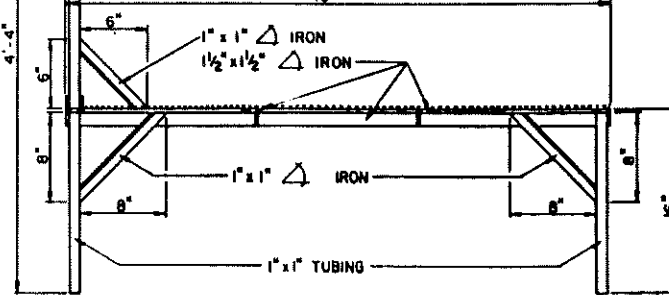
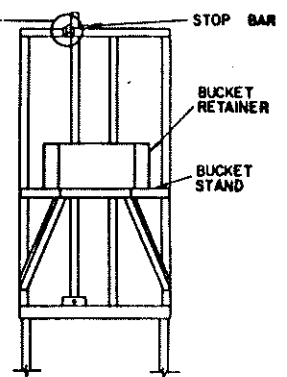
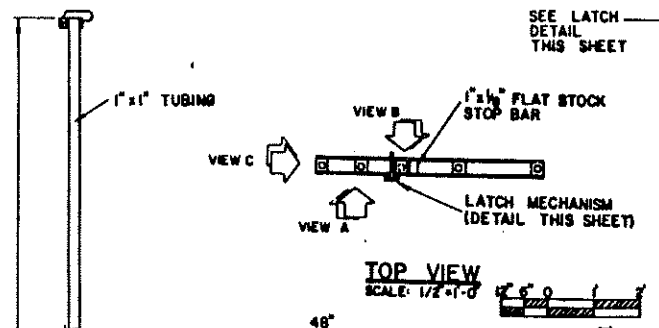

COOPERATIVE EXTENSION SERVICE AGRICULTURE AND HOME ECONOMICS		
AND UNITED STATES DEPARTMENT OF AGRICULTURE COOPERATING		
<b>GOAT MILKING STAND - METAL</b>		
FL '88	6399	SHEET 1 OF 1