

DOOR SCHEDULE			
MARK	SIZE	TYPES	NO REQ'D
1	3'-0" x 6'-8"	EXTERIOR - 2 LITE	1
2	2'-8" x 6'-8"	INTERIOR - FLUSH PANEL	3
3	3'-0" x 6'-8"	EXTERIOR - 3 LITE	1
4	2'-4" x 6'-8"	INTERIOR - FLUSH PANEL	1
5	3'-0" x 6'-8"	SCREENED	2

INCLUDE SCREENED AND/OR STORM DOOR FOR ALL EXTERIOR UNITS.

WINDOW SCHEDULE			
MARK	SIZE	TYPE	NO REQ'D
A	6'-0" x 4'-2 3/4"	STEEL CASEMENT	1
B	4'-8" x 4'-2 3/4"	"	1
C	3'-4" x 4'-2 3/4"	"	1
D	2'-0" x 3'-2 3/4"	"	5
E	3'-4" x 3'-2 3/4"	"	1

OPERATING SASH TO INCLUDE SCREEN AND/OR STORM SASH.

ELECTRICAL KEY	
	CEILING OUTLET
	CONVENIENCE OUTLET
	RANGE OUTLET
	WALL SWITCH
	3 WAY SWITCH

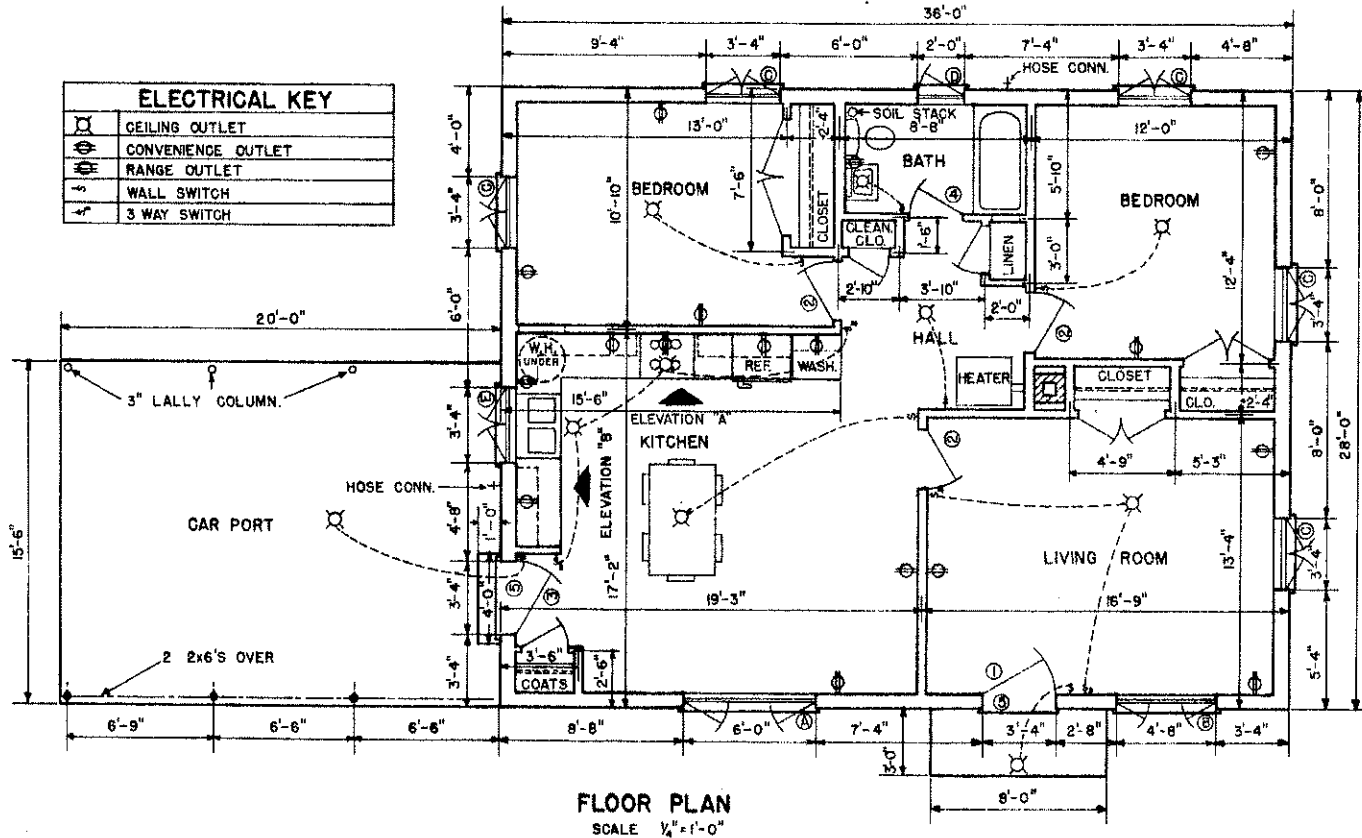

FLOOR PLAN
SCALE 1/4" = 1'-0"

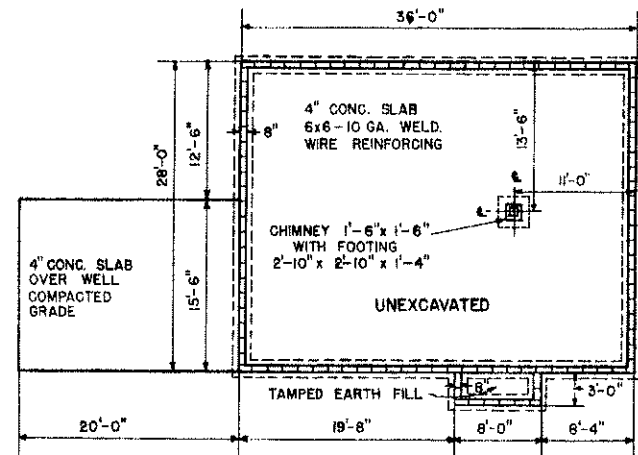

FOUNDATION PLAN
SCALE 1/4" = 1'-0"

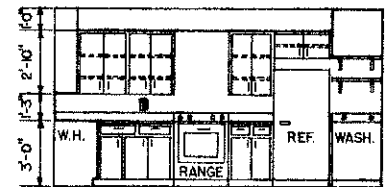

ELEVATION "A"

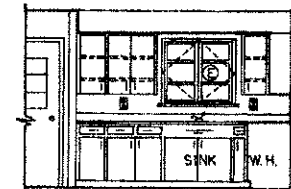

ELEVATION "B"

KITCHEN ELEVATIONS
SCALE 1/4" = 1'-0"

COOPERATIVE EXTENSION WORK IN AGRICULTURE AND HOME ECONOMICS

STATE OF NORTH DAKOTA
NORTH DAKOTA STATE UNIVERSITY
OF AGRICULTURE AND MECHANICAL ARTS
AND
UNITED STATES DEPARTMENT OF AGRICULTURE COOPERATING

2 BEDROOM FARMHOUSE
MASONRY CONSTRUCTION

USDA '64 EX. 7172 SHEET 1 OF 2

GLUE-NAIL GUSSETS

USE 4-d NAILS FOR NAILING GUSSETS AND 6-d NAILS FOR SCABS AND SPLICE PLATES. SPACE NAILS 4 INCHES APART IN TWO ROWS. DRIVE NAILS SO HEADS ARE BURIED IN THE PLYWOOD.
USE EITHER-RESORCINOL GLUE OR WATERPROOF CASEIN.

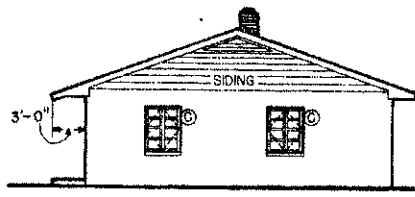
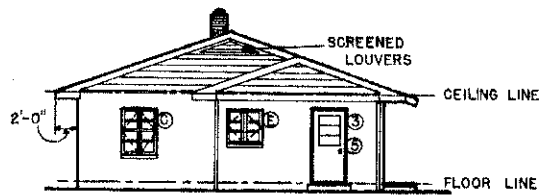
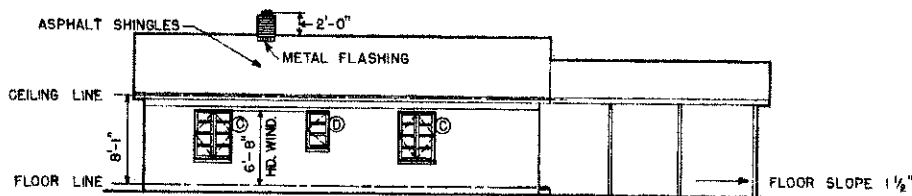
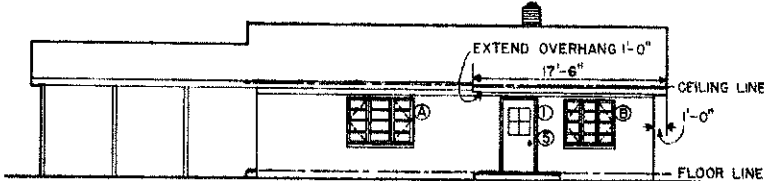
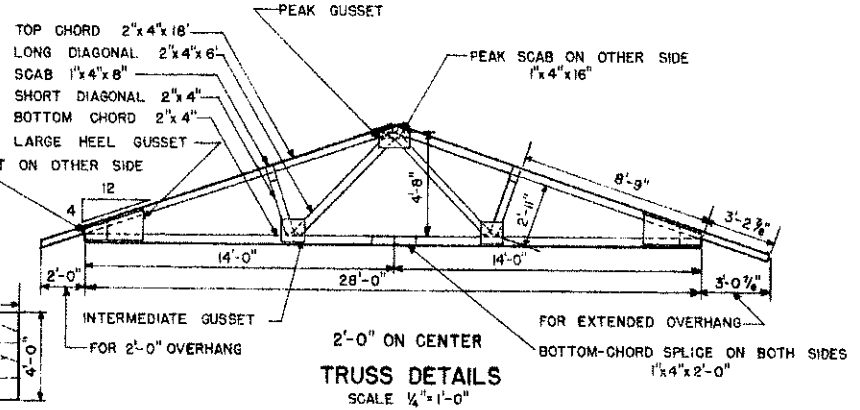
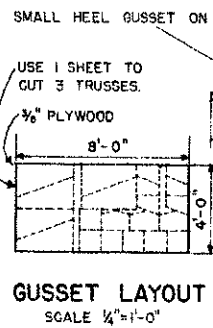
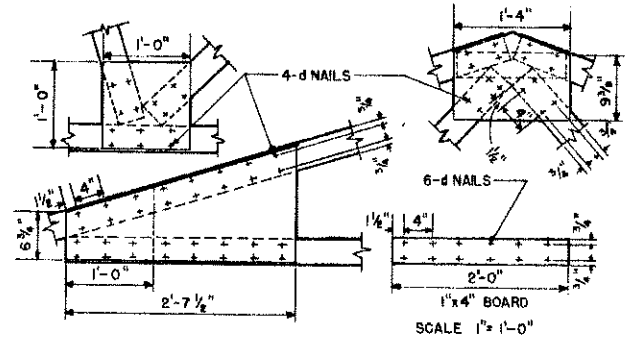

SCALE 1/4" = 1'-0"

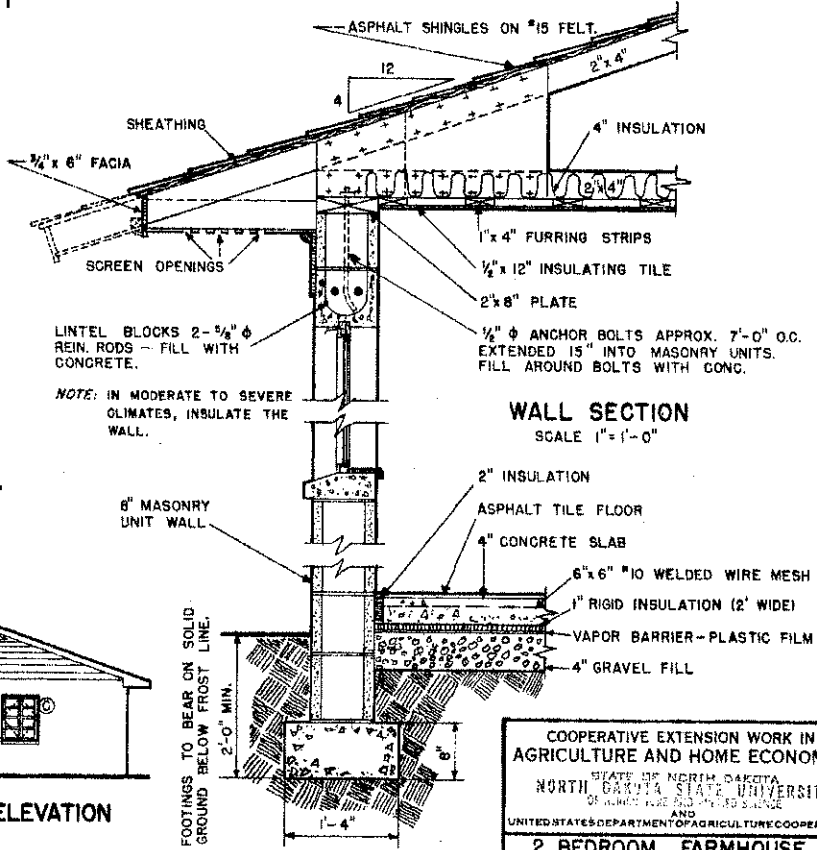

COOPERATIVE EXTENSION WORK IN AGRICULTURE AND HOME ECONOMICS
STATE OF NORTH DAKOTA
NORTH DAKOTA STATE UNIVERSITY
OF AGRICULTURE AND MECHANICAL ARTS
AND
UNITED STATES DEPARTMENT OF AGRICULTURE COOPERATING
2 BEDROOM FARMHOUSE
MASONRY CONSTRUCTION
USDA '64 EX. 7172 SHEET 2 OF 2