

PLAN

NOTE: EXTERIOR DIMENSIONS TO FACE OF STUDS.
ALL OTHERS TO CENTER OF STUDS,
UNLESS OTHERWISE INDICATED.

ELECTRICAL KEY	
MARK	TYPE
S	SINGLE POLE SWITCH
S ₃	THREE WAY SWITCH
⊕	DUPLEX CONVENIENCE OUTLET
⊕	WATERPROOF DUPLEX OUTLET
⊕	WATERPROOF WALL OUTLET
⊕	RANGE OUTLET
⊕	WATER HEATER OUTLET
⊕	SPECIAL PURPOSE OUTLET
⊕	CEILING OUTLET W/PULL SWITCH
⊕	FLUORESCENT FIXTURE

DOOR SCHEDULE			
MARK	SIZE	TYPE	NO REQD
①	3'-0" x 6'-8"	WOOD SOLID CORE, EXTERIOR	3
②	2'-6" x 6'-8"	WOOD HOLLOW CORE, INTERIOR	2
③	5'-0" x 6'-8"	WOOD LOUVERED BI-FOLD	3
④	3'-6" x 6'-8"	"	2
⑤	2'-0" x 6'-8"	"	2

WINDOW SCHEDULE			
MARK	SIZE	TYPE	NO REQD
△	6'-0" x 4'-0"	ALUMINUM CASEMENT (P.F.P)	2
△	4'-0" x 3'-0"	"	2
△	3'-0" x 4'-0"	"	1
△	8'-0" x 4'-0"	"	1

HTR = HEATER VTR = VENT THRU ROOF WH = WATER HEATER

NOTE: CHECK LOCAL CODES BEFORE STARTING CONSTRUCTION

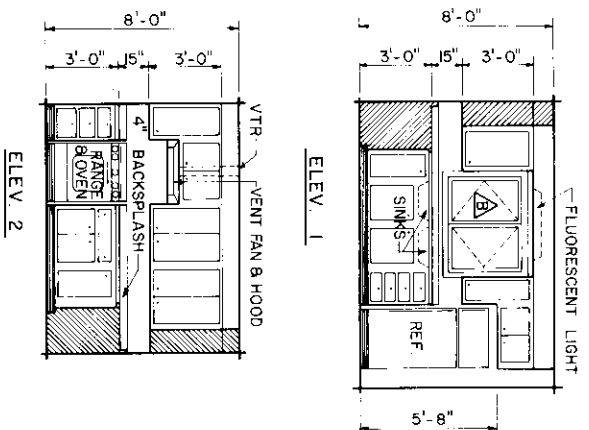

KITCHEN ELEVATIONS

BATH ELEVATION

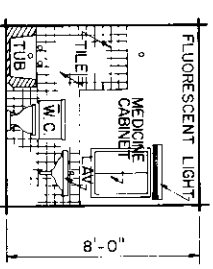

COOPERATIVE EXTENSION WORK IN
AGRICULTURE AND HOME ECONOMICS

UNITED STATES DEPARTMENT OF AGRICULTURE COOPERATING

TWO BEDROOM HOUSE WITH CARPORT

SC 8505A '74 7204 SHEET 1 OF 3

BASED ON CLEMSON UNIV. PLAN '70

COMMERCIAL TYPE TRUSS @ 2'-0" O.C.

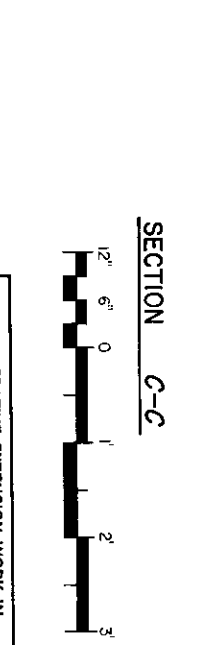
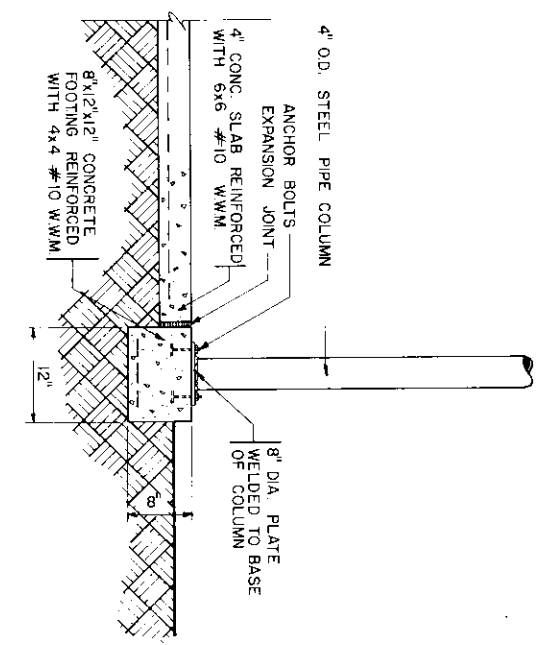
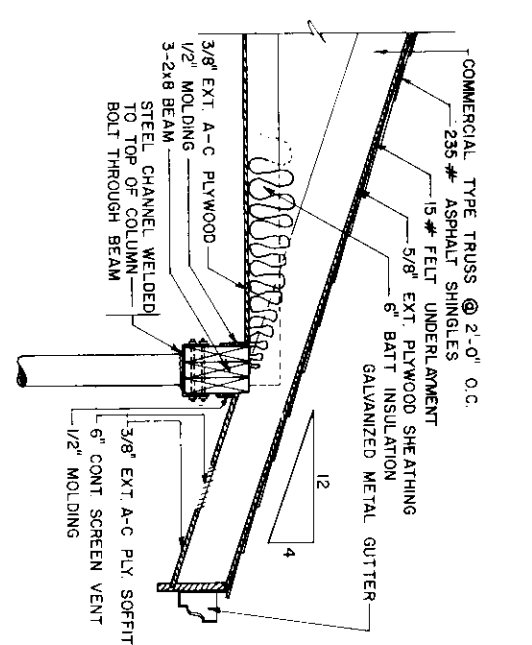
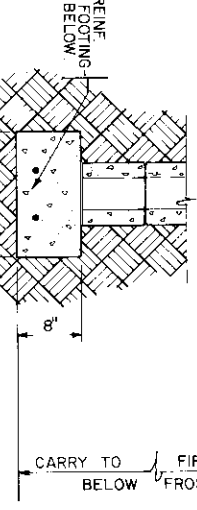
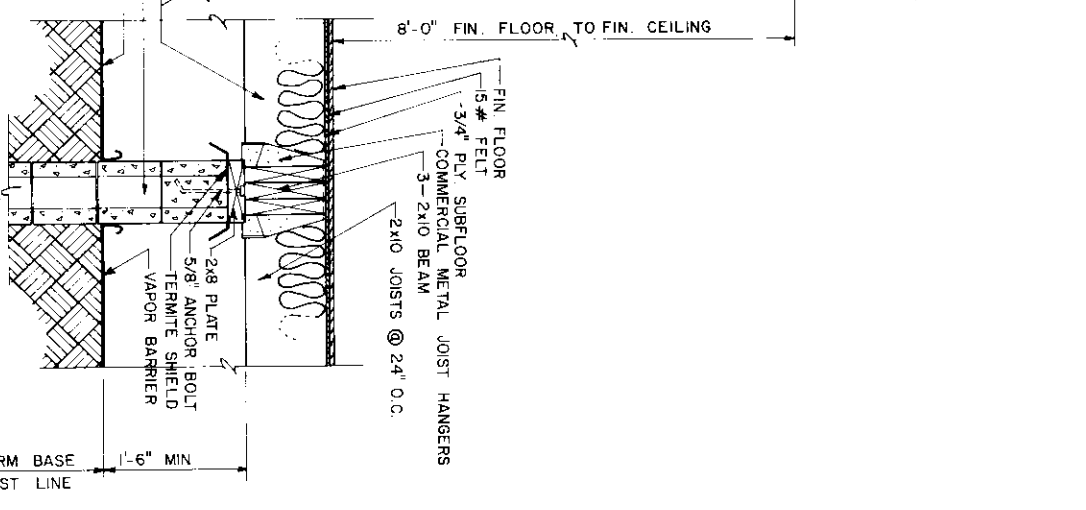
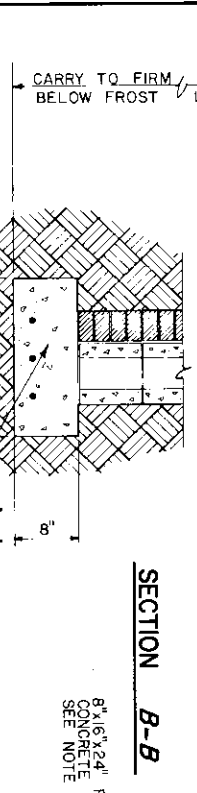
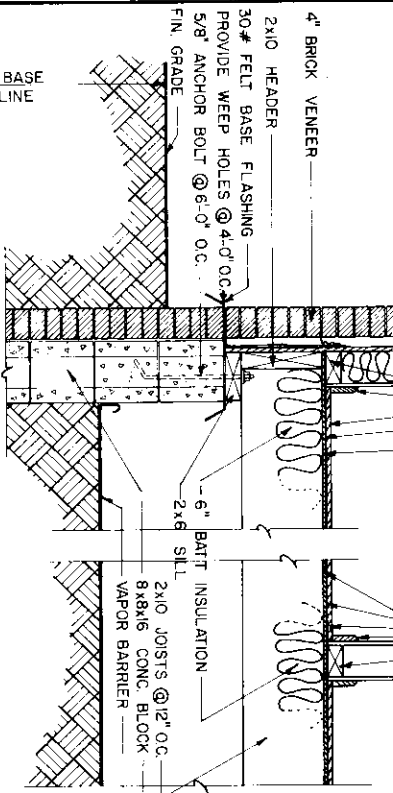
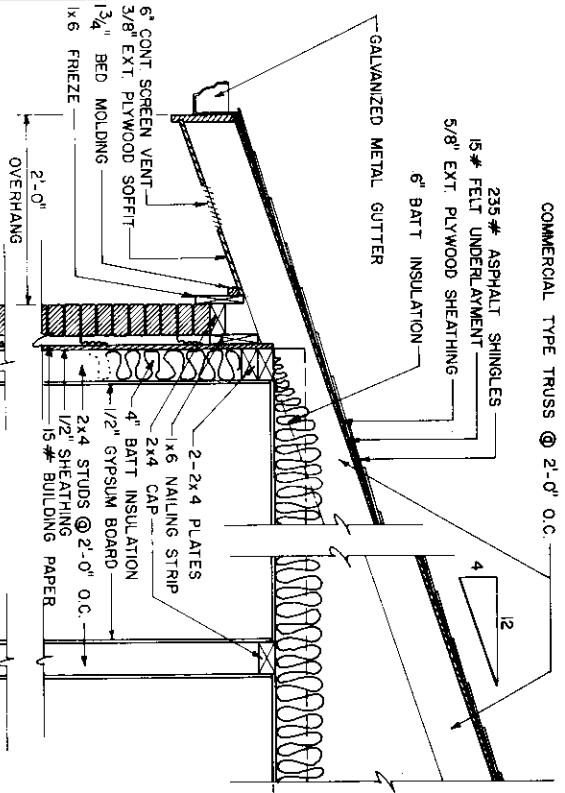

NOTE: ACTUAL FOOTING SIZE AND SIZE & AMOUNT OF REINFORCING BARS DEPENDS ON SOIL TYPE AND PROPERTIES. CHECK LOCAL CODES.

COOPERATIVE EXTENSION WORK IN AGRICULTURE AND HOME ECONOMICS

UNITED STATES DEPARTMENT OF AGRICULTURE
AND
NATIONAL COOPERATIVE EXTENSION SERVICE
TWO BEDROOM HOUSE WITH CARPORT
SC.BUSDA 74 7204 SHEET 2 OF 3

